

# Modular Drawer in Shelving

DRAWER IN SHELVING



## MAXIMIZE STORAGE CAPABILITY

Say goodbye to poorly lit shelves, backaches, and difficulty accessing materials caused by inadequate storage! Let us help you redesign your space.

As storage specialists, we recommend integrating Rousseau drawers with your shelving to get the most out of it. Opt for a hybrid and versatile system that has proved itself over and over for the past 25 years.

With their sturdy construction and distinctive appearance, Rousseau drawers add value to your existing equipment. The Rousseau modular drawer can be installed in over 35 brands of shelving on the market, making it possible to keep existing materials. A simple and economic solution... **Just think about it!**



### CURRENT SITUATION

- 1 Top and bottom shelves used less and hard to reach.
- 2 Poor lighting at the back of shelves.
- 3 Visibility of items hampered by shelves blocking field of vision.
- 4 Unused space between shelves. Not optimized

RESULT : Items are harder to locate and taking inventory is more difficult.

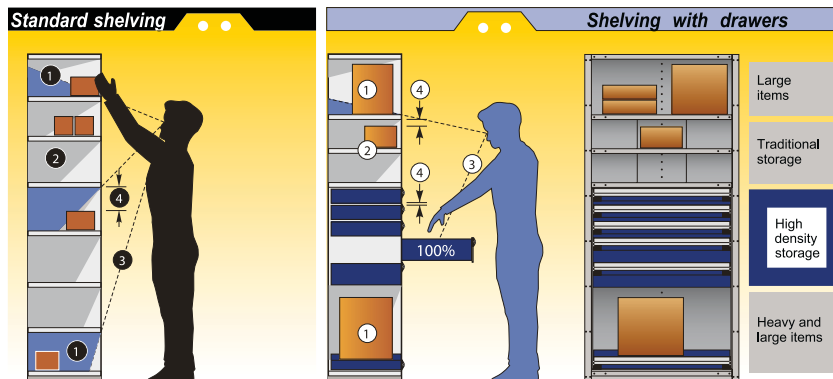

### OUR RECOMMENDATIONS

- 1 More widely spaced shelves for larger items.
- 2 Close-set shelves positioned at eye level.
- 3 Objects are easy to locate in drawers that open 100%.
- 4 Use of space optimized, based on the size of stored items.

RESULT : Better organized storage, easy to inventory.

## The Rousseau Advantages

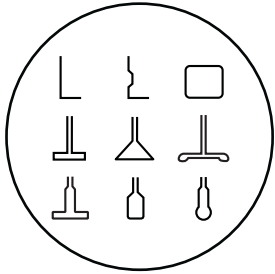

Can be installed in over 35 brands of shelving on the market. Easy and quick hook-on assembly for most brands of shelving.

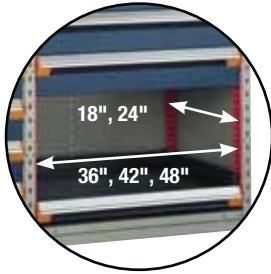

Several dimensions available : 36", 42" and 48" W by 18" and 24" D. Same brackets for different dimensions.



10 drawer heights and 7 side heights available.

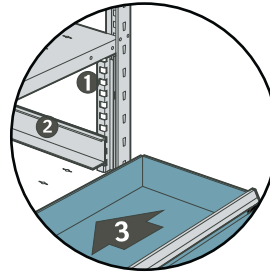

Easy and fast installation :  
1. Hook brackets on;  
2. Hook rails on;  
3. Insert carriages and drawers.



400 lb capacity per drawer. Most durable drawer in the industry.

## General Dimensions



**NOTE** Popular dimensions shown in red.

Index	Page(s)
<b>Modular Drawer in Shelving</b>	82 - 83
Proposals	84 - 85
Components	86 - 87
Accessories	88
Assembly and Security Recommendations	89

## In Order To Save Space

Instead of building an addition onto your building, choose high density storage and optimize your investments!

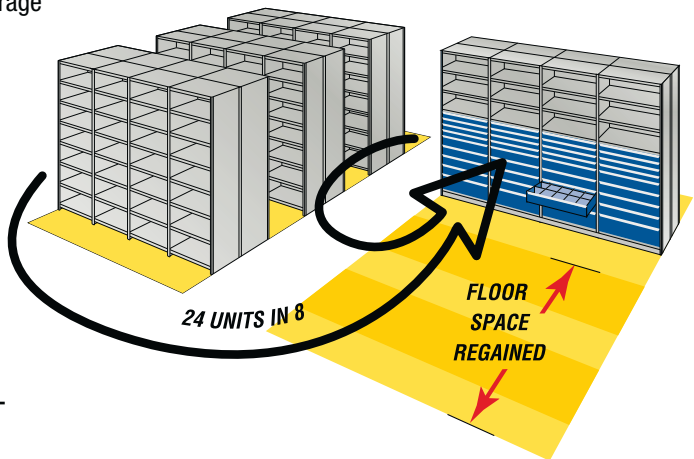
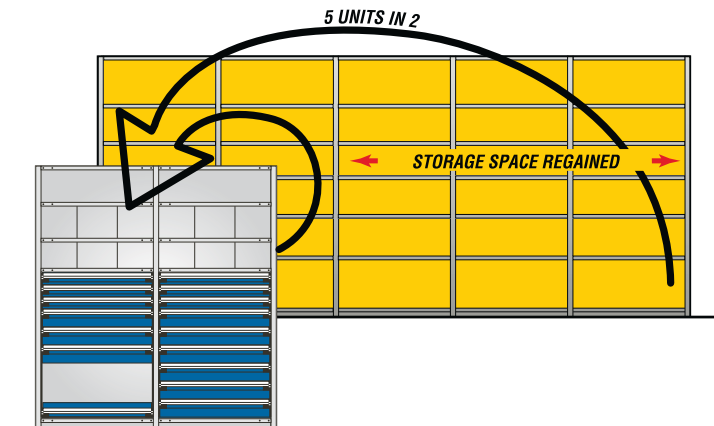

Ask our expert consultants for an in-depth survey of your potential savings.

# Proposals

DRAWER IN SHELVING

Presented here are some of the most popular modular drawers in shelving models.

Rousseau modular drawers are adaptable to more than 35 brands of shelving available on the market;

All models include mounting brackets for Spider® shelving. Please specify the shelving brand when ordering.

SEE PAGE 87

**IMPORTANT**

Drawer partitions are included in models.

**NOTE**

For drawers without partitioning, complete the even number following the two last digits of the models.

Ex. : R5LEC-1801 with R5LEC-1802 without

**NOTE** Shelving must be ordered separately.

SEE PAGES 73-75



R5SEE-874811



Shelving with drawers must be anchored to the floor.

Number of Compartments (layout code)						
Drawer dimensions	36" x 18"	36" x 24"	42" x 18"	42" x 24"	48" x 18"	48" x 24"
3" to 5"	24 (0518)	30 (0524)	20 (0512)	30 (0524)	32 (0724)	40 (0732)
6" to 8"	8 (0304)	12 (0308)	12 (0308)	12 (0308)	10 (0405)	15 (0410)
9" and higher	6 (0203)	9 (0206)	6 (0203)	8 (0304)	8 (0304)	8 (0304)

**NOTE** For inside dimensions.

SEE PAGE 140-141

## 18" H Bank of Drawers for Shelving



R5LEE-1801

- 4 drawers :
- 3-4" drawers
  - 1-6" drawer

Product #	W x D
R5LEC-1801	36" x 18"
<b>R5LEE-1801</b>	36" x 24"
R5LGC-1801	42" x 18"
R5LGE-1801	42" x 24"
R5LHC-1801	48" x 18"
R5LHE-1801	48" x 24"

**NOTE** Shelving must be ordered separately.

## 24" H Bank of Drawers for Shelving



R5LEE-2401

- 5 drawers :
- 3-4" drawers
  - 2-6" drawers

Product #	W x D
R5LEC-2401	36" x 18"
<b>R5LEE-2401</b>	36" x 24"
R5LGC-2401	42" x 18"
R5LGE-2401	42" x 24"
R5LHC-2401	48" x 18"
R5LHE-2401	48" x 24"

**NOTE** Shelving must be ordered separately.

## 36" H Bank of Drawers for Shelving



R5LEE-3601

- 7 drawers :
- 3-4" drawers
  - 4-6" drawers

Product #	W x D
R5LEC-3601	36" x 18"
<b>R5LEE-3601</b>	36" x 24"
R5LGC-3601	42" x 18"
R5LGE-3601	42" x 24"
R5LHC-3601	48" x 18"
R5LHE-3601	48" x 24"

**NOTE** Shelving must be ordered separately.



R5LEE-3603

- 7 drawers :
- 4-4" drawers
  - 2-6" drawers
  - 1-8" drawer

Product #	W x D
R5LEC-3603	36" x 18"
<b>R5LEE-3603</b>	36" x 24"
R5LGC-3603	42" x 18"
R5LGE-3603	42" x 24"
R5LHC-3603	48" x 18"
R5LHE-3603	48" x 24"

**NOTE** Shelving must be ordered separately.

## 48" H Bank of Drawers for Shelving



R5LEE-4801

8 drawers :  
- 8-6" drawers

Product #	W x D
R5LEC-4801	36" x 18"
<b>R5LEE-4801</b>	36" x 24"
R5LGC-4801	42" x 18"
R5LGE-4801	42" x 24"
R5LHC-4801	48" x 18"
R5LHE-4801	48" x 24"

**NOTE** Shelving must be ordered separately.



R5LEE-4803

9 drawers :  
- 4-4" drawers  
- 4-6" drawers  
- 1-8" drawer

Product #	W x D
R5LEC-4803	36" x 18"
<b>R5LEE-4803</b>	36" x 24"
R5LGC-4803	42" x 18"
R5LGE-4803	42" x 24"
R5LHC-4803	48" x 18"
R5LHE-4803	48" x 24"

**NOTE** Shelving must be ordered separately.



R5LEE-4805

10 drawers :  
- 6-4" drawers  
- 4-6" drawers

Product #	W x D
R5LEC-4805	36" x 18"
<b>R5LEE-4805</b>	36" x 24"
R5LGC-4805	42" x 18"
R5LGE-4805	42" x 24"
R5LHC-4805	48" x 18"
R5LHE-4805	48" x 24"

**NOTE** Shelving must be ordered separately.



R5LEE-4807

11 drawers :  
- 4-3" drawers  
- 3-4" drawers  
- 4-6" drawers

Product #	W x D
R5LEC-4807	36" x 18"
<b>R5LEE-4807</b>	36" x 24"
R5LGC-4807	42" x 18"
R5LGE-4807	42" x 24"
R5LHC-4807	48" x 18"
R5LHE-4807	48" x 24"

**NOTE** Shelving must be ordered separately.



R5LEE-4809

7 drawers and 1 front access roll-out shelf :  
- 2-3" drawers  
- 3-4" drawers  
- 2-6" drawers

Product #	W x D
R5LEC-4809	36" x 18"
<b>R5LEE-4809</b>	36" x 24"
R5LGC-4809	42" x 18"
R5LGE-4809	42" x 24"
R5LHC-4809	48" x 18"
R5LHE-4809	48" x 24"

**NOTE** Shelving must be ordered separately.

## Drawers, Roll-out Shelves and Locking or Security Mechanisms

DRAWER IN SHELVING

### Heavy-Duty Modular Drawer



RF32 / RF36



Drawer in painted steel: RF32;  
Drawer with stainless steel drawer front: RF36;  
400 lb capacity, 100% extension;  
Heavy-duty construction;  
Easy to install;

Vast choice of accessories offered to adapt to your storage needs;

Available drawer heights :  
3", 4", 5", 6", 7", 8", 9", 10", 12" and 14";

For modular drawers with layouts,

Order by adding the drawer height to the part # and by specifying the type of drawer front (painted steel or stainless steel). Ex.: RF32-362406.

Product #	W x D
RF -3618	36" x 18"
RF -3624	36" x 24"
RF -4218	42" x 18"
RF -4224	42" x 24"
RF -4818	48" x 18"
RF -4824	48" x 24"

SEE PAGES 157-161

SEE PAGES 143-156

### Lock-Out Mechanism

RF85



For both drawers and roll-out shelves;

Locks drawers and roll-out shelves in open position;

Activated manually, only when required;

Compatible with all accessories drawer;

Plastic bins positioned in the back row, may make it more difficult to activate mechanism.

Product #

RF85

### Lock

L3



Compatible with all drawer dimensions;

Does not affect usable drawer space;

Easy to retrofit;

Order by adding L3 to drawer or partitioning model number.

Ex. : RF32-362406L3.

For replacement parts or to retrofit this mechanism, order RY01-L3.

Product #

L3



### Heavy-Duty Front Access Roll-Out Shelf

RF41



400 lb capacity, 100% extension;

Heavy-duty construction;

Easy to install;

Painted steel with 3" edges on back and sides;

Height : 6";

Full access to contents.

Product #	W x D
RF41-3618	36" x 18"
RF41-3624	36" x 24"
RF41-4218	42" x 18"
RF41-4224	42" x 24"
RF41-4818	48" x 18"
RF41-4824	48" x 24"

### Security Panel

RF91

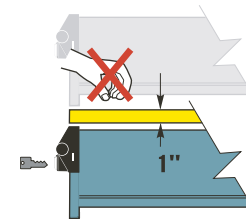

Compatible with drawer locks;

Blocks access between two drawers;

Usable space in the bank of drawers is reduced by 1";

Installed between two drawers.

Product #	W x D
RF91-3618	36" x 18"
RF91-3624	36" x 24"
RF91-4218	42" x 18"
RF91-4224	42" x 24"
RF91-4818	48" x 18"
RF91-4824	48" x 24"

### Heavy-Duty 3-Sided Access Roll-Out Shelf

RF45



400 lb capacity, 100% extension;

Heavy-duty construction;

Easy to install;

Galvanized steel with 1 1/2" edge on back;

Height : 5";

Full access to contents.

Product #	W x D
RF45-3618	36" x 18"
RF45-3624	36" x 24"
RF45-4218	42" x 18"
RF45-4224	42" x 24"
RF45-4818	48" x 18"
RF45-4824	48" x 24"



## Mounting Brackets

### Standard Mounting Brackets

RE00

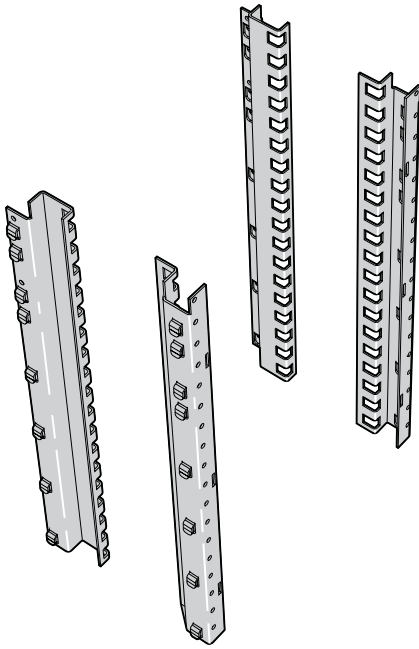

Rousseau modular drawers are adaptable to more than 35 brands of shelving available on the market.

#### COMPATIBLE UPRIGHT EXAMPLES

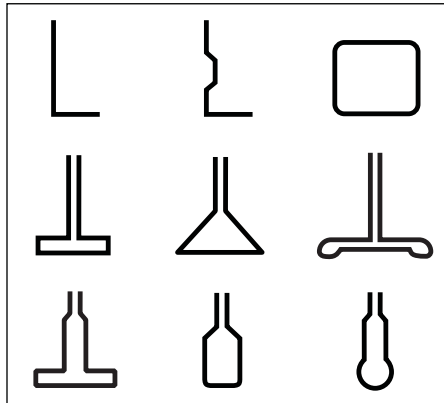

Easy hook-on assembly for most brands of shelving;  
Standard heights : 18", 24", 36" and 48";

The mounting bracket kit is compatible with all drawer widths for Rousseau shelving (36", 42" and 48");

Each kit includes 2 front and 2 rear mounting brackets and all necessary hardware;

Holes at every 1" c/c for drawer adjustment;

Two mounting bracket sets may be stacked simply by installing a shelf between them. The total height of the drawers should not exceed 60". Ex.: 36" + 18" = 54" is safe;

To order mounting brackets of non-standard heights, contact our customer service;

To order, complete the product number with the code for your brand of shelving. Ex.: RE30-48 for Rousseau Spider® shelving.

SEE PAGE 89

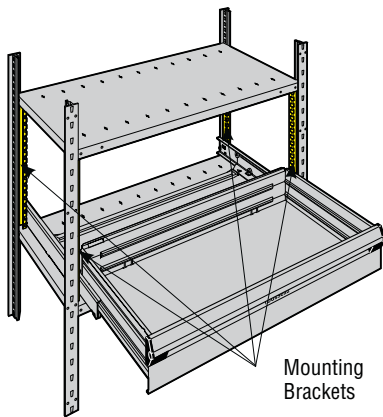

Mounting Brackets

Product #	Height
RE_-18	18"
RE_-24	24"
RE_-36	36"
RE_-48	48"

CODES FOR BRANDS OF SHELVING		
Company	Brand	Code
Adapto	Vector	RE45
Aurora	Quik-Lok	RE04
Bilt Industries	Klip-Bilt II	RE18
Borroughs	Steel Shelving	RE02
Easyup	7000	RE31
Equipto	V-Grip	RE29
EZ Rect	Type I	RE14
EZ Rect	Trime Line	RE26
Hallowell	Hi-Tech Shelving	RE07
Inca	Inca-matic	RE10
Lyon	8000	RE16
Metalware	Interlok	RE05
Penco	Clipper	RE08
Penco	Erectomatic	RE07
Republic	Clip Shelving	RE20
Rousseau	"0"	RE01
<b>Rousseau</b>	<b>Spider®</b>	<b>RE30</b>
Spacesaver	4-post Shelving	RE04
Tennsco	L&T Shelving	RE04
Tennsco	Q-Line	RE43
Tri-Boro	Steel Shelving	RE33
Triple A	600	RE27
Western Pacific	Clip Shelving	RE22
Western Pacific	Deluxe	RE24

Other mounting brackets are available. If your brand of shelving is not listed here, contact our customer service.

Brands indicated are the property of their respective owners.

DRAWER IN SHELVING

### Custom-Order Mounting Brackets

Rousseau can manufacture mounting brackets for new brands of shelving. Contact our customer service for more information.

# Accessories

DRAWER IN SHELVING

## Vertical Security Bar

## RE80 Filler

## RE90



Locks a bank of drawers in shelving with either a key or a padlock;  
 Lock or safety hasp for padlock is located at the top of the bar to facilitate access;  
 Covers a bank of drawers from 18" to 48" high;  
 Easy hook-on assembly;  
 Possible to install more than one bar on the same bracket for different users;  
 Installs on the right side;  
 36" high bar is compatible with 34" high mounting brackets and 48" high bar is compatible with 46" high mounting brackets;

Offered for Rousseau Spider® shelving. For Spacesaver shelving, order RE81-XXXXA instead of RE80-XXXXA;

Specify type of lock to place order. For a safety hasp add LP to the number and for a standard lock add L3 to the number.



Product #	Height
RE80-18_A	18"
RE80-24_A	24"
RE80-30_A	30"
RE80-36_A	36"
RE80-48_A	48"

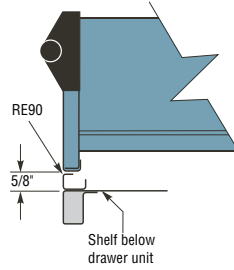

Installs with an adhesive strip under the bank of drawers;

Meets aesthetic requirements of certain work environments (hospitals, offices, etc.);

Offered for Rousseau Spider® and Spacesaver shelving only;

For Spacesaver shelving, order RE90-XX02 instead of RE90-XX01.

Product #	W x H
RE90-3601	36" x 5/8"
RE90-4201	42" x 5/8"
RE90-4801	48" x 5/8"

**NOTE**

Other accessories for Spider® shelving are available in the Spider® Shelving System section.

SEE PAGES 67-72

**NOTE**

To lock drawers in all other brands of shelving, see drawer lock (L3).

SEE PAGE 86

## Some Accomplishments



## Stacking Brackets

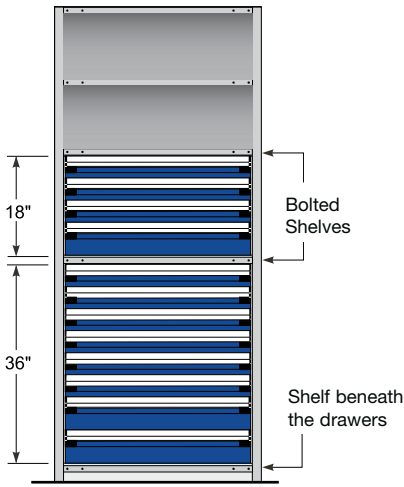

Two sets of mounting brackets can be stacked if a shelf is bolted between the two sections of drawers. Ex.: 36" + 18".

**IMPORTANT**  
The height of the top drawer must not exceed 60", unless you have the proper equipment to reach drawers higher than 60" in a safe manner.



## Assembly

Assemble using simple tools in three easy steps :

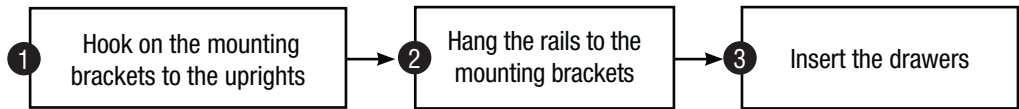

**Warning:** Make sure that the shelving structure has been installed in compliance with manufacturer recommendations.

**Warning:** Anchoring shelving (particularly single rows) to the floor is mandatory.

To anchor Spider® shelving units,



SEE PAGE 74

The minimum space required for drawers depends on the height of the mounting brackets.

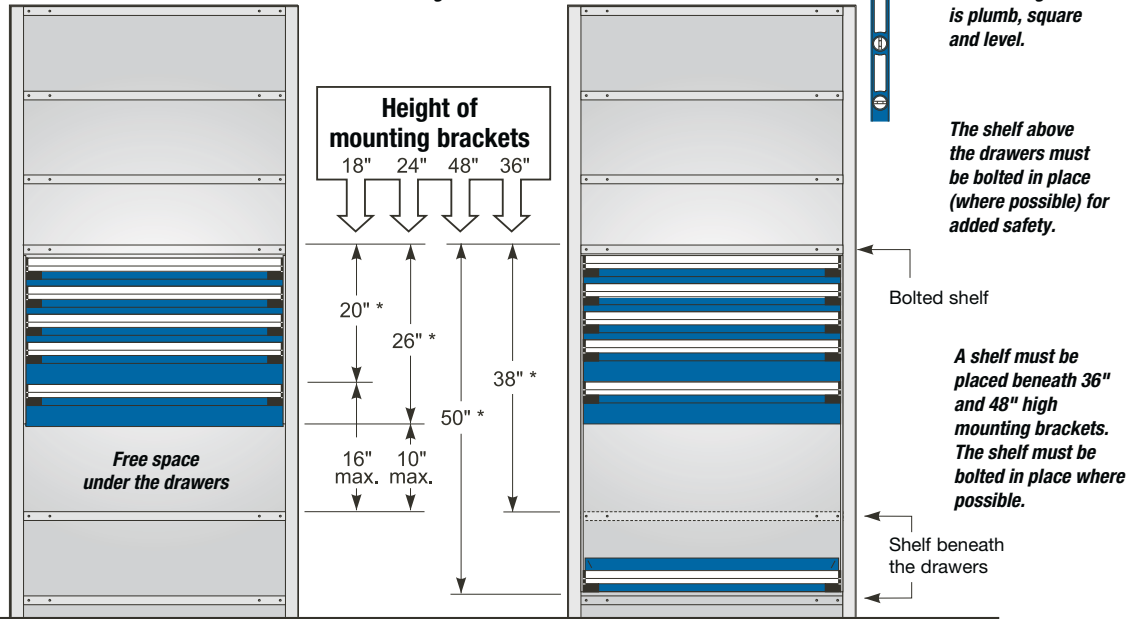

Make sure that the shelving is plumb, square and level.

The shelf above the drawers must be bolted in place (where possible) for added safety.

A shelf must be placed beneath 36" and 48" high mounting brackets. The shelf must be bolted in place where possible.

To the floor or wall

\* Subtract 1/2" for shelving with 1 1/2" adjustable shelves (c/c).