

Wood Frame Shelving - Single Faced

General Assembly

Tools Required:

Two 5/16 Wrenches, Phillips Screwdriver

Parts Included:

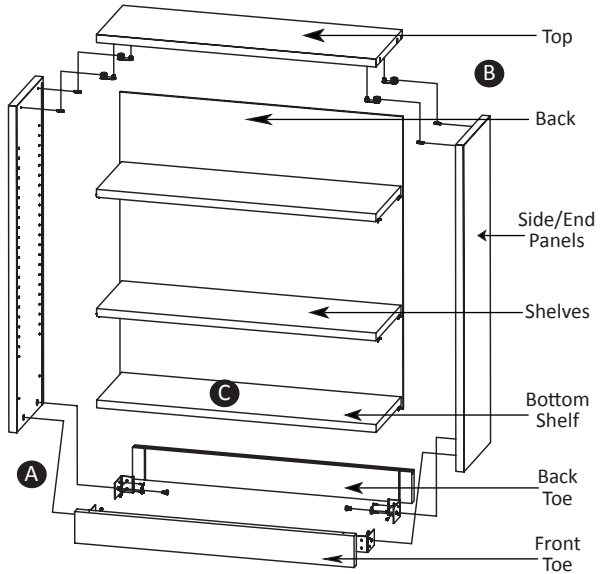
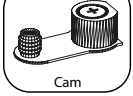
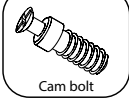
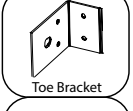
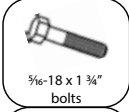

ATTENTION: UNITS ARE ASSEMBLED STANDING UP

A

STEP 1 - Attaching the toes to the sides

For Initial Bookshelf Unit:

Slide a toe-bracket into the groove on the back toe and the front toe. Make sure bracket is flush with toe. Screw into both toes using #8 x 5/8" screws. **THEN** bolt toe-brackets to end panel using 5/16-18 x 3/4" bolts. Finger tight for now.

- Position back toe with groove facing up and align with groove in side panel.
- Save second end panel for the end of run- if assembling stand alone unit attach second end panel now.

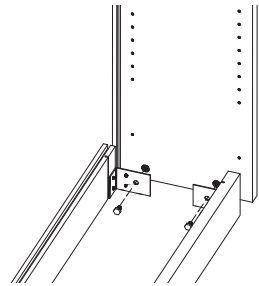

Special applications may require shelving unit be floor-anchored. Failure to do so could cause instability and injury.

For Adder Units:

Attach toe-bracket to toes and intermediate panel same as above. **THEN** bolt through one toe-bracket, intermediate panel and next z-bracket with 5/16-18 x 1 3/4" bolts and nuts. Finger tight.

- Grooves on all initial and adder units should be installed toward the bookshelf back.

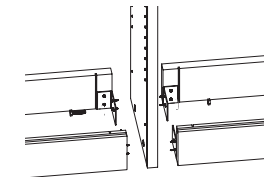

Lay out all initial, adder and end units but **DO NOT** tighten bolts, yet.

- All bottoms **must** be level relative to each other shim if necessary.

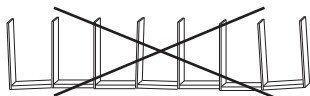
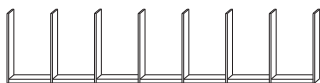

Wood Frame Shelving - Single Faced

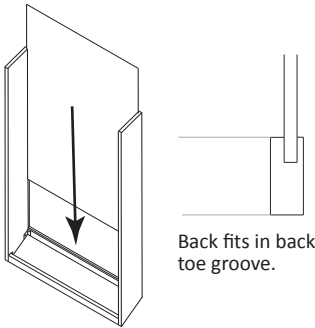

Back fits in back toe groove.

STEP 2 - Attaching the backs

Slip the back into the grooves in the side panels and bottom frame. The side panels will push outward because the bolts on the bottom frame are not tightened.

- Start sliding the back into the groove at a height in which the width of the back will fit in the grooves so as not to scratch the side panels.

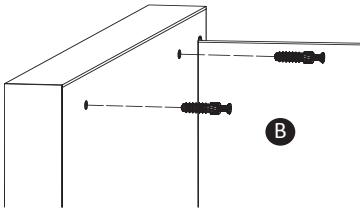

STEP 3 - Attaching the cams

Screw cam bolts into pre-bored holes in top of side panels.

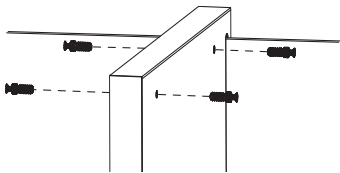

For Adder Units:

Screw cam bolts into pre-bored holes in both sides of top of intermediate panels.

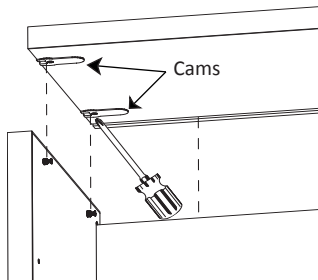

STEP 4 - Attaching the tops

Insert cams into pre-drilled holes in top, then align cams onto the studs and tighten about ¼ turn clockwise.

- A groove in the rear of a single-sided top captures the back panel.

**Do not use a screw gun!*



**Do Not Use
Screw Gun**



REMEMBER
STEP 5 →

STEP 5 - Now tighten all bolts!

Go back and tighten all bolts from steps 1 and 2.

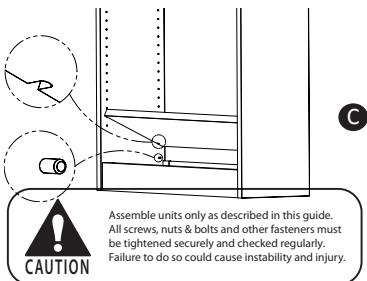

STEP 6 - Attaching the bottom shelf

Slip pin into the holes located near the bottom back side of each side panel (see illustration left). Lower shelf into place so pin fits into groove on underside of shelf. Front of shelf rests on toe.



Assemble units only as described in this guide. All screws, nuts & bolts and other fasteners must be tightened securely and checked regularly. Failure to do so could cause instability and injury.

STOREMORESTORE

Wood Frame Shelving - Single Faced

Wood

Steel

Fixed shelf pin

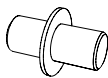

STEP 7 - Installing shelves

For wood shelves: Slip round pin of shelf clips into appropriate line holes in side panels and lower shelf into place so pointed portion of shelf clip is inserted into pre-drilled holes on underside of shelf.

For steel shelves: Slip shouldered pins into aligned holes in side panels and install shelves (4 pins per shelf).

For fixed wood shelves on units 60" and taller:

On shelving units 60" and taller a fixed shelf will be installed at the beginning and end of the run (as shown below). Fixed shelves should be placed mid-height of bookcase and attached to the end and intermediate panels using fixed shelf pins tightened into the pre-drilled holes.

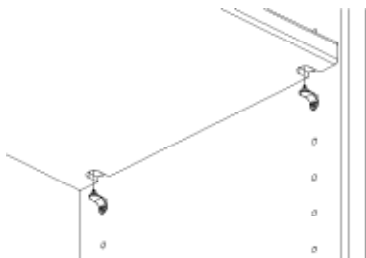

Locate fixed shelves mid-height on each end of shelving run and attach using (4) short cam studs per shelf

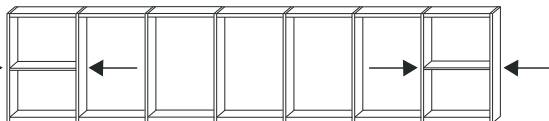

For fixed steel shelves on units 60" and taller:

Substitute (4) Varianta screws for standard steel shelf pins on a middle shelf of the book case at each end of a run

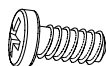

Varianta Screw

2 euro screws on each end of shelf

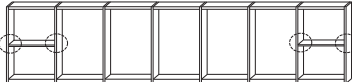

2 euro screws on each end of shelf

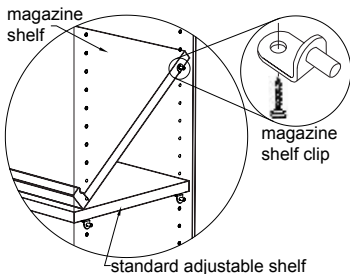

STEP 8 - Installing magazine shelves

Note: There is one less magazine/standard shelf combo per face than on a similar height standard shelving unit.

Insert one shelf clip into pre-drilled hole in underside of magazine shelf far enough forward so that shelf can rotate freely and secure with a small screw (#8 X 5/8" or equiv.) Place post of shelf clip into appropriate line hole. Now place post of second shelf clip into appropriate line hole on other side and position shelf onto clip. Attach second clip to underside of shelf.

Attaching Single Face Units To Wall

NOTE FOR STABILITY:

For all single faced units, an angle bracket is provided for attaching the bookstack to a wall. **The bracket should be aligned to screw into a support or stud.** Next, position bracket with the longer tab against the underside of the top of the bookcase and make sure the shorter tab is flat against the back of the bookcase. Screw bracket into top of bookcase first using #8 X 5/8" PH screws, then screw into the wall through the back panel - using the appropriate anchor for the wall type.

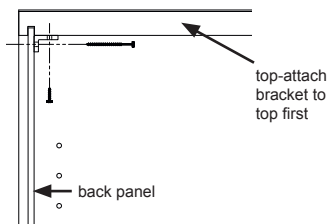

Make sure bookstack is flat against wall from top to bottom.



Assemble units only as described in this guide. All screws, nuts & bolts and other fasteners must be tightened securely and checked regularly. Failure to do so could cause instability and injury.

Wood Frame Shelving - Double Faced

General Assembly

Parts Included:

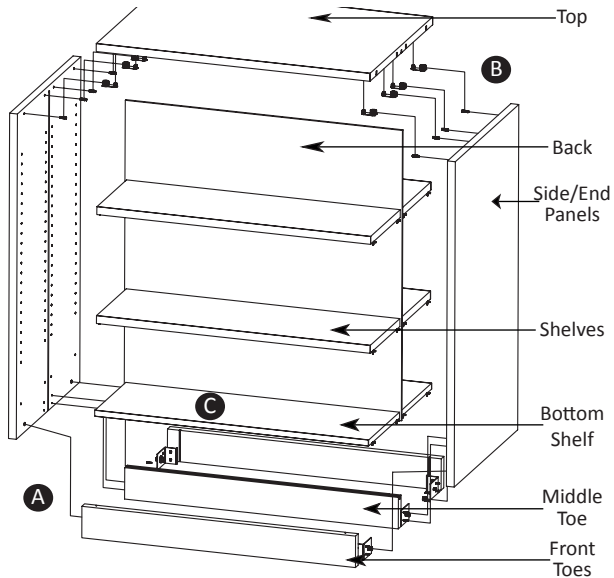
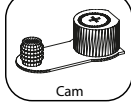
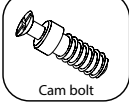
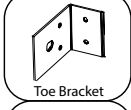
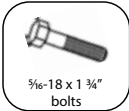

ATTENTION: UNITS ARE ASSEMBLED STANDING UP

STEP 1 - Attaching the toes to the sides

For Initial Bookshelf Unit:

Slide a z-bracket into the groove on each front toe and one side of the middle toe. Screw into all three toes and end panel using #8 x 5/8" pan head wood screws. **THEN** bolt both front toe z-brackets to end panel using 5/16-18 x 3/4" bolts. Finger tight for now. The middle toe has no bolt.

- Position middle toe with groove facing up and align with groove in side panel.
- Save second end panel for the end of run- if assembling stand alone unit attach second end panel now.

For Adder Units:

Attach z-bracket to toes and intermediate panel same as above. **THEN** bolt through one z-bracket, intermediate panel and next z-bracket with 5/16-18 x 1 3/4" bolts and nuts. Finger tight.

- Position middle toe with groove facing up and align with groove in side panel. Middle toe requires no bolt.



Special applications may require shelving unit be floor-anchored. Failure to do so could cause instability and injury.

Lay out all initial, adder and end units but **DO NOT** tighten bolts, yet.

- All bottoms **must** be level relative to each other shim if necessary.



Assemble units only as described in this guide. All screws, nuts & bolts and other fasteners must be tightened securely and checked regularly. Failure to do so could cause instability and injury.



STOREMORESTORE

Wood Frame Shelving - Double Faced

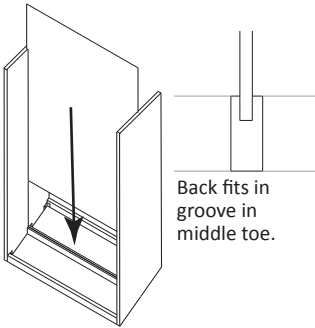

Back fits in groove in middle toe.

STEP 2 - Attaching the backs

Slip the back into the grooves in the side panels and lower into the groove of the middle toe.

- The side panels will push outward because the bolts on the bottom frame are not tightened. Start sliding the back into the groove at a height in which the width of the back will fit in the grooves so as not to scratch the side panels.

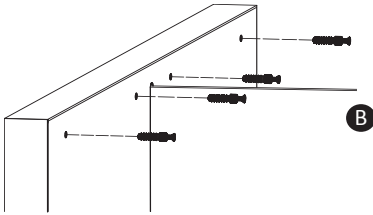

STEP 3 - Attaching the cams

Screw cam bolts into pre-bored holes in top of side panels.

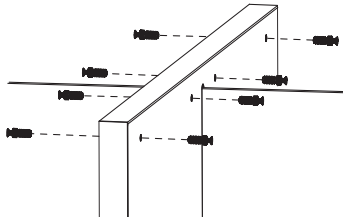

For Adder Units:

Screw cam bolts into pre-bored holes in both sides of top of intermediate panels.

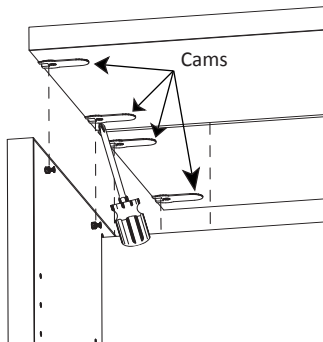

STEP 4 - Attaching the tops

Insert cams into pre-drilled holes in top, then align cams onto cam bolts. Tighten about ¼ turn clockwise.

- A groove in the middle of a double-sided top captures the back panel.

**Do not use a screw gun!*



REMEMBER
STEP 5

STEP 5 - Now tighten all bolts and brackets!



Assemble units only as described in this guide. All screws, nuts & bolts and other fasteners must be tightened securely and checked regularly. Failure to do so could cause instability and injury.

STOREMORESTORE

Wood Frame Shelving - Double Faced

STEP 6 - Attaching the bottom shelf

Slip pin into the holes located near the bottom back side of each side panel (see illustration left). Lower shelf into place so pin fits into groove on underside of shelf. Front of shelf rests on toe.

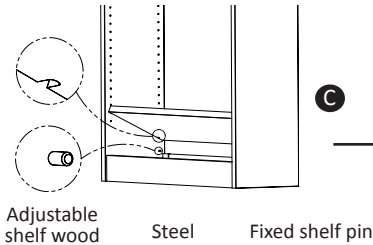

Step 7 – Installing Shelves

For wood shelves: Slip round pin of shelf clips into appropriate line holes in end panels and lower shelf into place so pointed portion of shelf clip is inserted into pre-drilled holes on underside of shelf.

For steel shelves: Slip shouldered pins into aligned holes in end panels and install shelves (4 pins per shelf).

Make sure shoulder is between shelf and end panel.

For fixed wood shelves on units 60" and taller:

On shelving units 60" and taller, a fixed shelf will be installed at the beginning and end of the run (as shown below).

Fixed shelves should be placed mid-height of bookcase and attached to the end and intermediate panels using fixed shelf pins tightened into the pre-drilled holes. One fixed shelf should be used on each end of a bookcase run. The fixed shelf may be located on either side of the double faced units.

Locate fixed shelves mid-height on each end of shelving run and attach using (4) fixed shelf supports per shelf.

For fixed steel shelves on units 60" and taller:

Substitute (4) Varianta Screws for standard steel shelf pins on a middle shelf of the book case at each end of the run. One fixed shelf should be installed on each side of double unit. Install Varianta Screw w/ #2 Pozzi Drive.

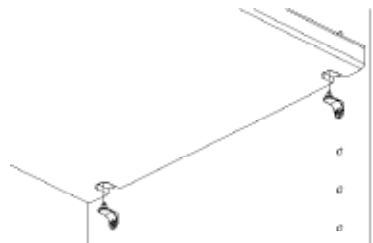

Fixed adjustable shelf receives routed grooves to accept fixed shelf pin

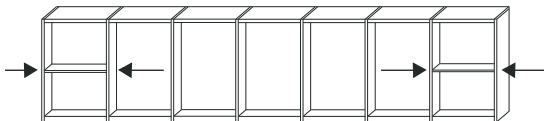

Varianta Screw

Note: For fixed shelves on mobile units:

Install fixed wood or steel shelf as indicated above, One fixed shelf is required per mobile unit, not "at each end of the run" as required above.

End panels will bow if fixed shelves are not installed. Failure to install per instructions could result in void of warranty.

STEP 8 - Installing magazine shelves

Note: There is one less magazine/standard shelf combo per face than on a similar height standard shelving unit.

Insert one shelf clip into pre-drilled hole in underside of magazine shelf far enough forward so that shelf can rotate freely and secure with a small screw (#8 X 5/8" or equiv.) Place post of shelf clip into appropriate line hole. Now place post of second shelf clip into appropriate line hole on other side and position shelf onto clip. Attach second clip to underside of shelf.

