

SOUTHWEST **SOLUTIONS** GROUP
business organization systems

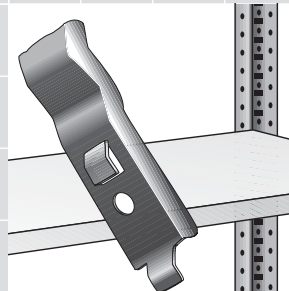
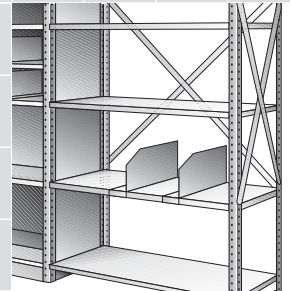
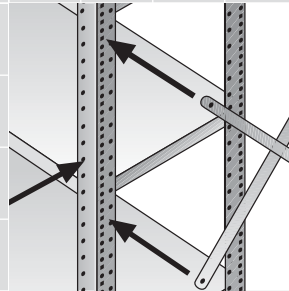
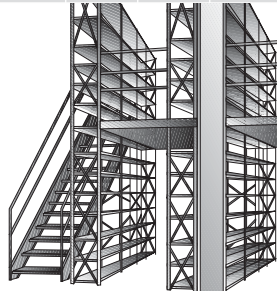
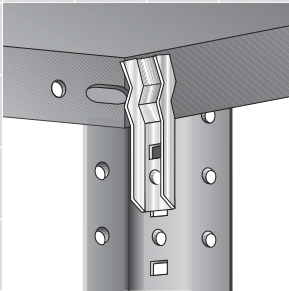
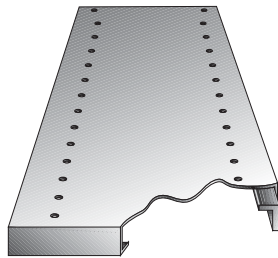
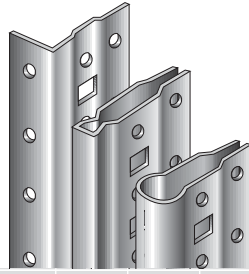

**Price List & Technical Manual
August 2009**

Pacific

Compression Clip Shelving

Pacific Clip Shelving

offers the versatility of inter-changeable components for all open and closed shelving units, the option of assembling with bolts and nuts (rather than clips), and the choice of front posts. "Starter" and "Adder" models are available in most sizes.

- Heights to 22' without splicing (most configurations)
- Widths to 48"
- Depths to 36"
- Standard heights 7'1" (85") and 8'1" (97")
- Vertical shelf adjustments in 1 1/2" increments

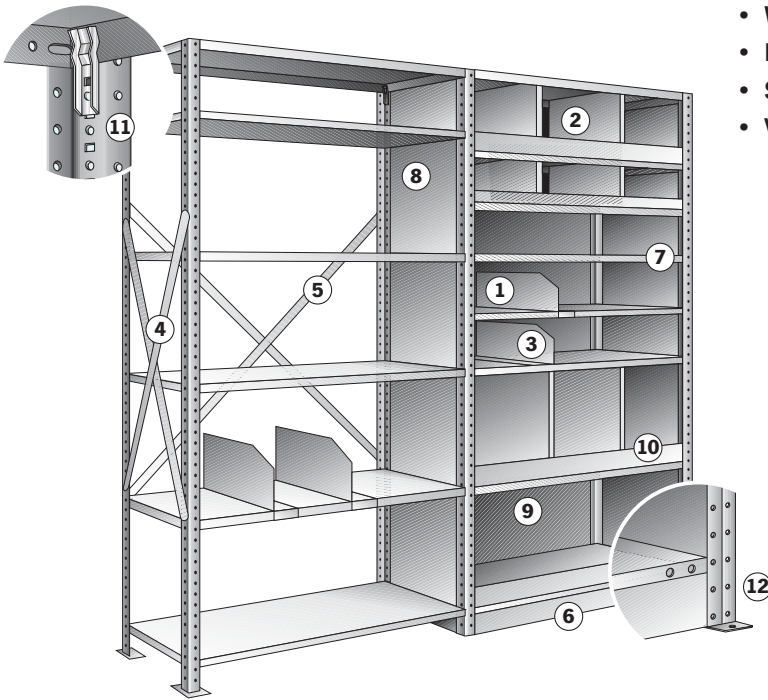

Shelving Components

1 Sliding Divider	7 Label Holder
2 Full Divider	8 End Panel
3 Angle Divider	9 Back Panel
4 Side Sway Braces	10 Bin Front
5 Back Sway Braces	11 Shelf Clip
6 Closed Base Strip	12 Foot Plate

Shelving System Growth

When determining sizes of Pacific shelving systems, the post size will increase the overall width and depth as shown below.

	Angle Post	Delta Post	Beaded Post
Add to Shelf Width:	3/8" per unit	3/8" per unit + 1/2" per row	3/8" per unit + 3/4" per row
Add to Shelf Depth:	1/16"	1/16"	13/16"
To Determine Shelf Clear Opening, Subtract from Shelf Width:	1 7/8"	1/8"	5/8"

Examples using 36" x 12" units, 2 wide by 2 deep

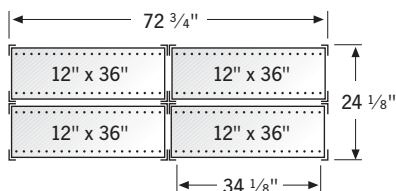

Angle Posts

Overall width = 72 3/4"
Overall depth = 24 1/8"
Clear opening per shelf = 34 1/8"

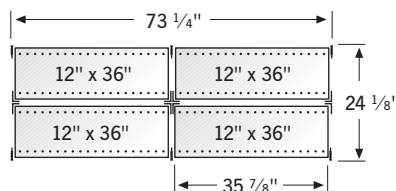

Delta Posts

Overall width = 73 1/4"
Overall depth = 24 1/8"
Clear opening per shelf = 35 7/8"

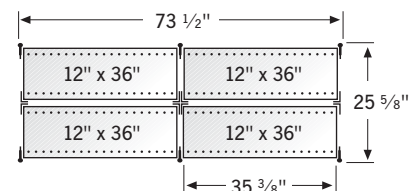

Beaded Posts

Overall width = 73 1/2"
Overall depth = 25 5/8"
Clear opening per shelf = 35 3/8"

Post Designs

- All posts roll formed of heavy gauge steel
- Posts adaptable to all storage arrangements except as noted
- Heights available from 5' to 22' (most styles)

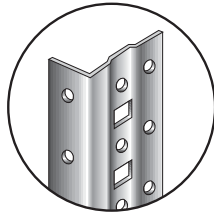

Angle Post

- Our most popular style
- Stiffening offset rib
- Ideal for seismic applications
- Always used as rear posts in combination with other posts
- Shelf access is reduced by 1 7/8"

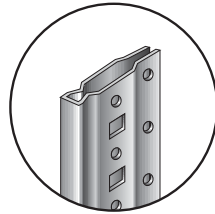

Delta Post

- Double-sided design with independent shelf positioning – ideal as common posts between multiple units
- Unobstructed shelf access
- Smooth front face for office applications
- Roll-formed of 14-gauge steel
- Not suitable for seismic or heavy-duty applications

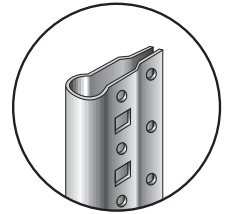

Beaded Post

- Double-sided design with independent shelf positioning – ideal as common posts between multiple units
- Maximum weight-bearing capacity for heavy-duty and mezzanine applications
- 13-gauge tubular steel design

Catwalk Systems

Engineered to meet or exceed all OSHA requirements, catwalk systems make use of wasted overhead space while minimizing utility costs.

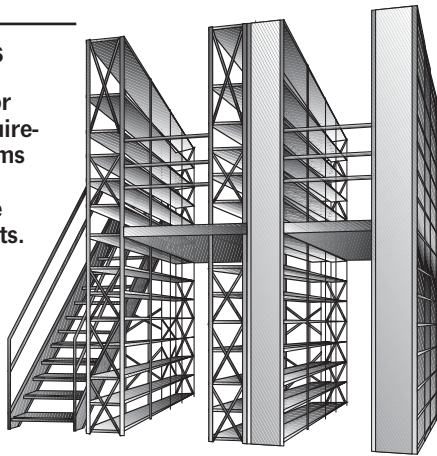

Shelf Clip

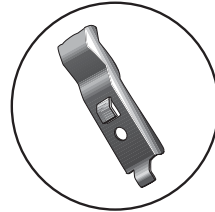

Designed for easy installation and repositioning, shelf clips are formed of heavy gauge steel for maximum weight bearing capability.

Calculating Post Height

First calculate the center-to-center spacing:

- 1 Determine the minimum clear vertical opening required per shelf.
- 2 Add 1 1/4" (shelf profile) and round up to the nearest 1/2" increment.

Next calculate the minimum post height:

- 3 Multiply the center-to-center distance by the required number of shelf openings.
- 4 Add 4" for the bottom shelf opening plus the profile of the first shelf. If you wish to bolt the first shelf closer to the ground, add either 2 1/2" or 1".

Example Shown (7 Shelves / 6 Shelf Openings)

If the minimum clear vertical opening is then the center-to-center spacing is

If 6 shelf openings are required the total post height is

$$= 11 \frac{3}{4}"$$

$$= 13 \frac{1}{2}"$$

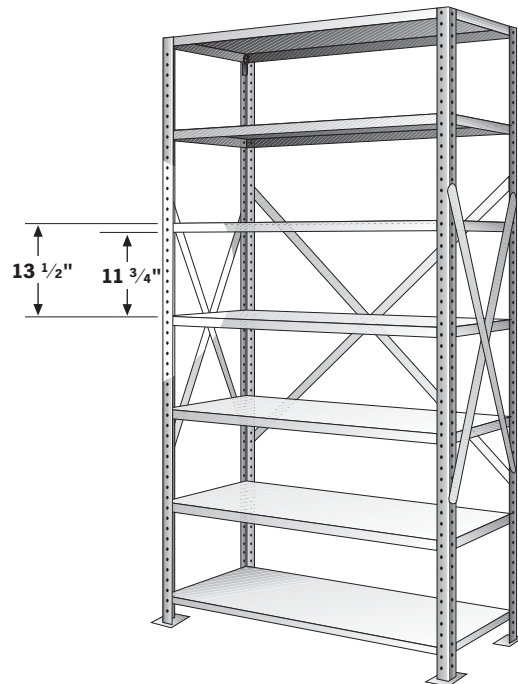
$$(13 \frac{1}{2}" \times 6) + 4" = 85"$$

Shelf Construction

- Shelves are 18 gauge, except Class 0, which are 20 gauge
- All shelves double flanged on sides and triple flanged front and rear
- Tops are punched on 2" centers for adjustment of dividers
- Front and rear faces are punched for label holders, angle sway braces and reinforcing bars and angles
- Standard widths: 30", 36", 42", 48"
- Standard depths: 12", 15", 18", 24", 30", 36"
- Note: reinforcing bars and angles are sold separately and installed at customer location

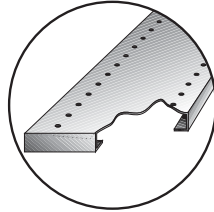

Class 0

- 20 gauge metal
- for light loads
- no reinforcements

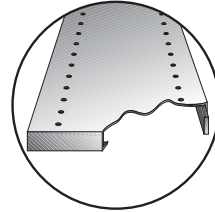

Class 1B

- 18 gauge metal
- for normal to medium loads
- 1" x 1/8" bar in front flange

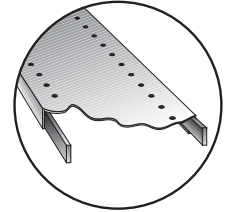

Class 2B

- 18 gauge metal
- for medium to heavy loads
- 1" x 1/8" bar in front and rear flanges

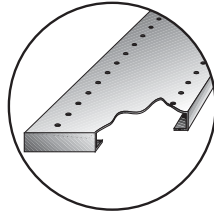

Class 1

- 18 gauge metal
- for normal loads
- no reinforcements

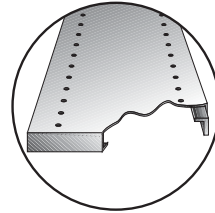

Class 1A

- 18 gauge metal
- for medium loads
- 1" x 1" x 1/8" angle in front

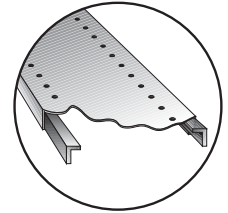

Class 2A

- 18 gauge metal
- for heavy loads
- 1" x 1" x 1/8" angle in front and rear flanges

Shelf Load Capacities

Shelf Size
Width/Depth

Weight Capacity (lbs./shelf)
Evenly Distributed Load

	Class 0	Class 1	Class 1B	Class 1A	Class 2B	Class 2A
30 x 12	N/A	865	976	1050	1389	1615
15	N/A	855	966	1040	1382	1610
18	N/A	845	956	1030	1372	1600
24	N/A	825	945	1025	1325	1525
30	N/A	805	931	1015	1270	1440
36	N/A	740	896	1000	1150	1250
36 x 12	400	775	853	905	1205	1405
15	390	765	843	895	1198	1400
18	380	760	835	885	1182	1380
24	360	750	825	875	1130	1300
30	N/A	745	817	865	1072	1210
36	N/A	730	802	850	1000	1100
42 x 12	240	475	550	600	792	920
15	250	470	542	590	779	905
18	260	465	531	575	764	890
24	290	455	521	565	730	840
30	275	445	514	560	701	795
32	270	425	503	555	642	700
36	250	425	503	555	642	700
48 x 12	210	360	400	440	500	610
15	220	375	400	445	510	620
18	230	390	415	450	525	630
24	250	425	450	475	550	650
30	210	345	365	395	430	510
36	200	335	350	375	410	450

Clip Shelving – Standard Open Units (Class 1 Shelves)

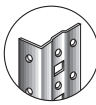

Shelves/Unit
Angle Post **5**

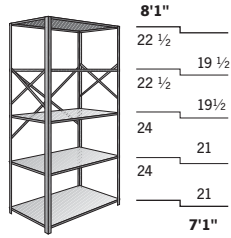

• Note: subtract 1 1/4" for clear opening height

Height	Width/Depth	Starter Unit			Adder Unit			
		Model No.	Wt. (lbs)	List (\$)	Model No.	Wt. (lbs)	List (\$)	
7'1"	36 x 12	107053612	66.7	152.85	107053612A	65.7	150.46	
		107053618	83.6	185.02	107053618A	82.4	181.22	
		107053624	100.4	219.86	107053624A	98.8	216.05	
		107053630	118.0	270.60	107053630A	115.6	264.29	
	8'1"	36 x 12	107053636	134.0	307.72	107053636A	131.6	300.87
			107054812	80.5	181.31	107054812A	79.5	178.92
			107054818	101.9	222.53	107054818A	100.7	218.72
			107054824	123.7	268.02	107054824A	122.1	264.21
		48 x 12	107054830	146.3	316.04	107054830A	143.9	309.73
			107054836	168.3	360.73	107054836A	165.9	353.88
			108053612	69.5	158.77	108053612A	68.5	156.38
			108053618	86.4	190.94	108053618A	85.2	187.13

Angle Post **6**

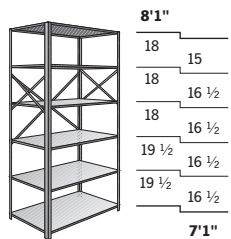

• Note: subtract 1 1/4" for clear opening height

7'1"	36 x 12	107063612	75.0	172.56	107063612A	74.0	170.17	
		107063618	95.2	210.60	107063618A	94.0	206.79	
		107063624	115.2	252.40	107063624A	113.6	248.59	
		107063630	136.0	312.29	107063630A	133.6	305.98	
	8'1"	36 x 12	107063636	155.2	356.62	107063636A	152.8	349.77
			107064812	91.4	206.31	107064812A	90.4	203.92
			107064818	117.0	255.21	107064818A	115.8	251.40
			107064824	143.0	309.80	107064824A	141.4	305.99
		48 x 12	107064830	169.8	366.43	107064830A	167.4	360.12
			107064836	196.2	419.84	107064836A	193.8	412.99
			108063612	77.8	178.48	108063612A	76.8	176.09
			108063618	98.0	216.52	108063618A	96.8	212.71

Angle Post **7**

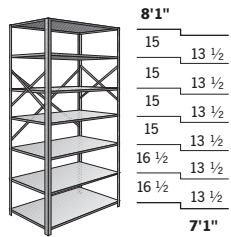

• Note: subtract 1 1/4" for clear opening height

7'1"	36 x 12	107073612	83.3	172.56	107073612A	82.3	170.17	
		107073618	106.8	210.60	107073618A	105.6	206.79	
		107073624	130.0	252.40	107073624A	128.4	248.59	
		107073630	154.0	312.29	107073630A	151.6	305.98	
	8'1"	36 x 12	107073636	176.4	356.62	107073636A	174.0	349.77
			107074812	102.3	231.32	107074812A	101.3	228.93
			107074818	132.1	287.89	107074818A	130.9	284.09
			107074824	162.3	351.58	107074824A	160.7	347.77
		48 x 12	107074830	193.3	416.81	107074830A	190.9	410.50
			107074836	224.1	478.95	107074836A	221.7	472.10
			108073612	86.1	198.19	108073612A	85.1	195.80
			108073618	109.6	242.09	108073618A	108.4	238.28

Model Number Explanation

1	07	08	36	12	A
Type of Unit	Nominal Height (ft.)	No. of Shelves	Width (in.)	Depth (in.)	Adder Unit (optional)

Types of Units

1 Open, Angle Post	5 Open, Beaded Post (front)
2 Closed, Angle Post	6 Closed, Beaded Post (front)
3 Open, Delta Post (front)	LD Light Duty
4 Closed, Delta Post (front)	

- Non-stock items
- Low stock items

Hardware included with Open Units:

- Nuts and bolts for top and bottom shelves
- Clips for intermediate shelves (optional for top and bottom)

Clip Shelving — Standard Open Units (Class 1 Shelves)

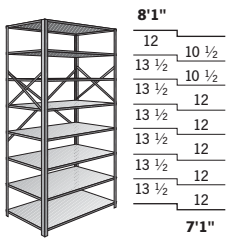
Shelves/Unit	Height	Width/Depth	Starter Unit			Adder Unit				
			Model No.	Wt. (lbs)	List (\$)	Model No.	Wt. (lbs)	List (\$)		
8 	7'1"	36 x 12	107083612	91.6	211.98	107083612A	90.6	209.59		
			107083618	118.4	261.76	107083618A	117.2	257.95		
		107083624	144.8	317.49	107083624A	143.2	313.68			
		• • 107083630	172.0	395.67	• • 107083630A	169.6	389.36			
		• • 107083636	197.6	454.42	• • 107083636A	195.2	447.57			
		48 x 12	107084812	113.2	231.32	107084812A	112.2	228.93		
	107084818		147.2	287.89	107084818A	146.0	284.09			
	107084824		181.6	351.58	107084824A	180.0	347.77			
	• • 107084830		216.8	416.81	• • 107084830A	214.4	410.50			
	• • 107084836		252.0	478.95	• • 107084836A	249.6	472.10			
	8'1"		36 x 12	108083612	94.4	217.90	108083612A	93.4	215.51	
		108083618		121.2	267.67	108083618A	120.0	263.86		
		108083624		147.6	323.40	108083624A	146.0	319.60		
		• • 108083630		174.8	401.58	• • 108083630A	172.4	395.27		
		• • 108083636		200.4	460.33	• • 108083636A	198.0	453.48		
		48 x 12		108084812	116.0	262.24	108084812A	115.0	259.85	
			108084818	150.0	326.49	108084818A	148.8	322.68		
			108084824	184.4	399.27	108084824A	182.8	395.47		
			• • 108084830	219.6	473.11	• • 108084830A	217.2	466.80		
			• • 108084836	254.8	543.97	• • 108084836A	252.4	537.11		
			Delta Post	7'1"	36 x 12	307053612	68.9	159.46	307053612A	61.6
		307053618				85.8	191.63	307053618A	78.3	173.85
	307053624	102.6			226.46	307053624A	94.7	208.68		
	• • 307053630	120.2			277.20	• • 307053630A	111.5	256.92		
• • 307053636	136.2	314.32			• • 307053636A	127.5	293.50			
48 x 12	307054812	82.7			212.91	307054812A	75.4	196.56		
	307054818	104.1		261.81	307054818A	96.6	244.04			
	307054824	125.9		316.40	307054824A	118.0	298.63			
	• • 307054830	148.5		373.03	• • 307054830A	139.8	352.75			
	• • 307054836	170.5		426.44	• • 307054836A	161.8	405.62			
	8'1"	36 x 12		308053612	72.1	166.15	308053612A	63.9	147.92	
308053618				89.0	198.32	308053618A	80.6	178.68		
308053624			105.8	233.15	308053624A	97.0	213.51			
• • 308053630			123.4	283.89	• • 308053630A	113.8	261.75			
• • 308053636			139.4	321.02	• • 308053636A	129.8	298.33			
48 x 12			308054812	85.9	194.60	308054812A	84.9	176.38		
		308054818	108.1	235.83	308054818A	99.3	216.18			
		308054824	129.1	281.32	308054824A	120.3	261.67			
		• • 308054830	151.7	329.34	• • 308054830A	142.1	307.19			
		• • 308054836	173.7	374.03	• • 308054836A	164.1	351.34			
		Delta Post	7'1"	36 x 12	307063612	77.2	179.17	307063612A	69.9	162.81
307063618					97.4	217.20	307063618A	89.9	199.43	
307063624	117.4			259.01	307063624A	109.5	241.23			
• • 307063630	138.2			318.89	• • 307063630A	129.5	298.61			
• • 307063636	157.4			363.22	• • 307063636A	148.7	342.40			
48 x 12	307064812			93.6	212.91	307064812A	86.3	196.56		
	307064818		119.2	261.81	307064818A	111.7	244.04			
	307064824		145.2	316.40	307064824A	137.3	298.63			
	• • 307064830		172.0	373.03	• • 307064830A	163.3	352.75			
	• • 307064836		198.4	426.44	• • 307064836A	189.7	405.62			
	8'1"		36 x 12	308063612	80.4	205.57	308063612A	72.2	187.34	
308063618				100.6	249.47	308063618A	92.2	229.83		
308063624		120.6		298.24	308063624A	111.8	278.60			
• • 308063630		141.4		367.27	• • 308063630A	131.8	345.13			
• • 308063636		160.6		418.81	• • 308063636A	151.0	396.13			
48 x 12		308064812		96.8	219.61	308064812A	88.6	201.38		
		308064818	122.4	268.51	308064818A	114.0	248.86			
		308064824	148.4	323.10	308064824A	139.6	303.45			
		• • 308064830	175.2	379.73	• • 308064830A	165.6	357.58			
		• • 308064836	201.6	433.14	• • 308064836A	192.0	418.90			

• Note: subtract 1 1/4" for clear opening height

• Delta in front only; Angle Posts at rear
 • Note: subtract 1 1/4" for clear opening height

• Delta in front only; Angle Posts at rear
 • Note: subtract 1 1/4" for clear opening height

Model Number Explanation

1	07	08	36	12	A
Type of Unit	Nominal Height (ft.)	No. of Shelves	Width (in.)	Depth (in.)	Adder Unit (optional)

Types of Units

1 Open, Angle Post	5 Open, Beaded Post (front)
2 Closed, Angle Post	6 Closed, Beaded Post (front)
3 Open, Delta Post (front)	LD Light Duty
4 Closed, Delta Post (front)	

- Non-stock items
- Low stock items

Hardware included with Open Units:

- Nuts and bolts for top and bottom shelves
- Clips for intermediate shelves (optional for top and bottom)

Clip Shelving – Standard Open Units (Class 1 Shelves)

Shelves/Unit	Height	Width/Depth	Starter Unit			Adder Unit				
			Model No.	Wt. (lbs)	List (\$)	Model No.	Wt. (lbs)	List (\$)		
Delta Post 7	7'1"	36 x 12	307073612	85.5	198.88	307073612A	78.2	182.52		
			307073618	109.0	242.78	307073618A	101.5	225.00		
			307073624	132.2	291.55	307073624A	124.3	273.77		
			•• 307073630	156.2	360.58	•• 307073630A	147.5	340.30		
			•• 307073636	178.6	412.12	•• 307073636A	169.9	391.30		
		48 x 12	307074812	104.5	237.92	307074812A	97.2	221.56		
			307074818	134.3	294.50	307074818A	126.8	276.72		
			307074824	164.5	358.18	307074824A	156.6	340.41		
			•• 307074830	195.5	423.42	•• 307074830A	186.8	403.14		
			•• 307074836	226.3	485.55	•• 307074836A	217.6	464.73		
		8'1"	8'1"	36 x 12	308073612	88.7	205.57	308073612A	80.5	187.34
					308073618	111.8	249.47	308073618A	103.6	229.83
					308073624	135.4	298.24	308073624A	126.6	278.60
					•• 308073630	159.4	367.27	•• 308073630A	149.8	345.13
					•• 308073636	181.8	418.81	•• 308073636A	172.2	396.13
48 x 12	308074812			107.7	244.61	308074812A	99.5	226.39		
	308074818			137.5	301.19	308074818A	129.1	281.55		
	308074824			167.7	364.88	308074824A	158.9	345.23		
	•• 308074830			198.7	430.11	•• 308074830A	189.1	407.96		
	•• 308074836			229.5	492.24	•• 308074836A	219.9	469.56		
Delta Post 8	7'1"			36 x 12	307083612	93.8	218.59	307083612A	86.5	202.23
					307083618	120.6	268.36	307083618A	113.1	250.58
					307083624	147.0	324.09	307083624A	139.1	306.32
					•• 307083630	174.2	402.27	•• 307083630A	165.5	381.99
					•• 307083636	199.8	461.02	•• 307083636A	191.1	440.20
		48 x 12	307084812	114.6	262.93	307084812A	107.3	246.57		
			307084818	149.4	327.18	307084818A	141.9	309.40		
			307084824	183.8	399.96	307084824A	175.9	382.19		
			•• 307084830	219.0	473.80	•• 307084830A	210.3	453.52		
			•• 307084836	254.2	544.66	•• 307084836A	245.5	523.84		
		8'1"	8'1"	36 x 12	308083612	97.0	225.28	308083612A	88.8	207.05
					308083618	123.8	275.05	308083618A	115.4	255.41
					308083624	150.2	330.79	308083624A	141.4	311.14
					•• 308083630	177.4	408.96	•• 308083630A	167.8	386.82
					•• 308083636	203.0	467.71	•• 308083636A	193.4	445.03
48 x 12	308084812			118.6	269.62	308084812A	110.4	251.39		
	308084818			152.6	333.87	308084818A	144.2	314.23		
	308084824			187.0	406.66	308084824A	178.2	387.01		
	•• 308084830			222.2	480.49	•• 308084830A	212.6	458.35		
	•• 308084836			257.4	551.35	•• 308084836A	247.8	528.66		
Beaded Post 5	7'1"			36 x 12	507053612	78.5	159.46	507053612A	66.4	143.10
					507053618	95.4	191.63	507053618A	83.1	173.85
					507053624	112.2	226.46	507053624A	99.5	208.68
					•• 507053630	129.8	322.65	•• 507053630A	116.3	302.37
					•• 507053636	145.8	367.34	•• 507053636A	132.3	346.52
		48 x 12	507054812	92.3	187.91	507054812A	80.2	171.55		
			507054818	113.7	229.13	507054818A	101.4	211.36		
			507054824	135.5	274.62	507054824A	122.8	256.85		
			•• 507054830	158.1	322.65	•• 507054830A	144.6	302.37		
			•• 507054836	180.1	367.34	•• 507054836A	166.6	346.52		
		8'1"	8'1"	36 x 12	508053612	69.3	166.15	508053612A	81.9	147.92
					508053618	99.8	198.32	508053618A	86.0	178.68
					508053624	116.6	233.15	508053624A	102.4	213.51
					•• 508053630	134.2	283.89	•• 508053630A	119.2	261.75
					•• 508053636	150.2	321.02	•• 508053636A	135.2	298.33
48 x 12	508054812			96.7	194.60	508054812A	83.1	176.38		
	508054818			118.1	235.83	508054818A	104.3	216.18		
	508054824			139.9	281.32	508054824A	125.7	261.67		
	•• 508054830			162.5	329.34	•• 508054830A	147.5	307.19		
	•• 508054836			184.5	374.03	•• 508054836A	169.5	351.34		

Open Shelving	Starter Unit			Adder Unit		
	Angle Post	Delta Post	Beaded Post	Angle Post	Delta Post	Beaded Post
Posts (front)	(2) Angle	(2) Delta	(2) Beaded	(2) Angle	(1) Delta	(1) Beaded
Posts (rear)	(2) Angle	(2) Angle	(2) Angle	(2) Angle	(2) Angle	(2) Angle
Sway Braces (side/pair)	2	2	2	1	1	1
Sway Braces (rear/pair)	1	1	1	1	1	1

Clip Shelving – Standard Open Units (Class 1 Shelves)

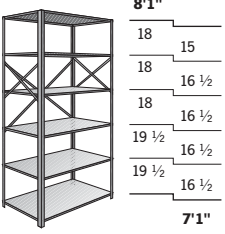
Shelves/Unit	Height	Width/Depth	Starter Unit			Adder Unit			
			Model No.	Wt. (lbs)	List (\$)	Model No.	Wt. (lbs)	List (\$)	
6 Beaded Post 	7'1"	36 x 12	507063612	86.8	189.24	507063612A	74.7	162.89	
			507063618	107.0	233.56	507063618A	94.7	207.61	
			507063624	127.0	275.36	507063624A	114.3	249.41	
			•• 507063630	147.8	322.97	•• 507063630A	134.3	293.56	
			•• 507063636	167.0	365.60	•• 507063636A	153.5	336.20	
		48 x 12	507064812	103.2	224.76	507064812A	91.1	198.40	
			507064818	128.8	276.19	507064818A	116.5	250.24	
			507064824	154.8	337.13	507064824A	142.1	309.47	
			•• 507064830	181.6	395.50	•• 507064830A	168.1	366.10	
			•• 507064836	208.0	452.99	•• 507064836A	194.5	423.59	
		8'1"	36 x 12	508063612	91.2	198.62	508063612A	77.6	169.00
				508063618	111.4	242.61	508063618A	97.6	212.56
	508063624			131.4	286.17	508063624A	117.2	255.24	
	•• 508063630			152.2	331.47	•• 508063630A	137.2	298.80	
	•• 508063636			171.4	373.28	•• 508063636A	156.4	340.61	
	48 x 12			508064812	107.5	234.12	508064812A	94.0	204.72
			508064818	133.2	290.09	508064818A	119.4	260.04	
			508064824	159.2	346.71	508064824A	145.0	315.79	
			•• 508064830	186.0	405.08	•• 508064830A	171.0	372.41	
			•• 508064836	212.4	462.57	•• 508064836A	197.4	429.91	
			7'1"	36 x 12	507073612	95.1	207.11	507073612A	83.0
	507073618				118.2	259.14	507073618A	106.1	233.18
	507073624	141.8			308.82	507073624A	129.1	281.16	
	•• 507073630	165.8			361.09	•• 507073630A	152.3	331.69	
•• 507073636	188.2	409.87			•• 507073636A	174.7	380.47		
48 x 12	507074812	114.1			248.49	507074812A	102.0	222.14	
	507074818	140.7		310.85	507074818A	131.6	284.90		
	507074824	174.1		379.16	507074824A	161.4	351.50		
	•• 507074830	205.1		446.67	•• 507074830A	191.6	417.27		
	•• 507074836	235.9		513.75	•• 507074836A	222.4	484.35		
	8'1"	36 x 12		508073612	99.5	216.70	508073612A	85.9	187.08
508073618				123.0	267.88	508073618A	109.2	237.82	
508073624			146.2	318.40	508073624A	132.0	287.48		
•• 508073630			170.2	370.67	•• 508073630A	155.2	338.00		
•• 508073636			192.6	419.45	•• 508073636A	177.6	386.78		
48 x 12			508074812	118.5	258.08	508074812A	104.9	228.46	
		508074818	148.3	322.97	508074818A	134.5	292.92		
		508074824	178.5	388.74	508074824A	164.3	357.82		
		•• 508074830	209.5	456.26	•• 508074830A	194.5	423.59		
		•• 508074836	240.3	523.33	•• 508074836A	225.3	490.67		
		7'1"	36 x 12	507083612	103.4	225.19	507083612A	91.3	198.84
507083618				130.2	284.71	507083618A	117.9	258.76	
507083624	156.6			341.05	507083624A	143.9	313.40		
•• 507083630	183.8			400.29	•• 507083630A	170.3	370.88		
•• 507083636	209.4			456.04	•• 507083636A	195.9	426.64		
48 x 12	507084812			144.0	313.61	507084812A	112.9	287.26	
	507084818		159.0	343.53	507084818A	146.7	317.58		
	507084824		190.6	415.10	507084824A	180.7	387.44		
	•• 507084830		228.6	497.85	•• 507084830A	215.1	468.45		
	•• 507084836		263.8	574.51	•• 507084836A	250.3	545.11		
	8'1"		36 x 12	508083612	107.8	234.77	508083612A	94.2	205.15
508083618				134.6	293.14	508083618A	120.8	263.08	
508083624		161.0		350.63	508083624A	146.8	319.71		
•• 508083630		188.2		409.87	•• 508083630A	173.2	377.20		
•• 508083636		213.8		465.62	•• 508083636A	198.8	432.95		
48 x 12		508084812		129.4	281.81	508084812A	115.8	252.20	
		508084818	163.4	355.86	508084818A	149.6	325.81		
		508084824	197.8	430.78	508084824A	183.6	399.85		
		•• 508084830	233.0	507.44	•• 508084830A	218.0	474.77		
		•• 508084836	268.2	584.09	•• 508084836A	253.2	551.43		

Model Number Explanation

1	07	08	36	12	A
Type of Unit	Nominal Height (ft.)	No. of Shelves	Width (in.)	Depth (in.)	Adder Unit (optional)

Types of Units

1 Open, Angle Post	5 Open, Beaded Post (front)
2 Closed, Angle Post	6 Closed, Beaded Post (front)
3 Open, Delta Post (front)	LD Light Duty
4 Closed, Delta Post (front)	

- Non-stock items
- Low stock items

Hardware included with Open Units:

- Nuts and bolts for top and bottom shelves
- Clips for intermediate shelves (optional for top and bottom)

Clip Shelving – Standard Closed Units (Class 1 Shelves)

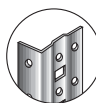

Shelves/Unit **Angle Post 5**

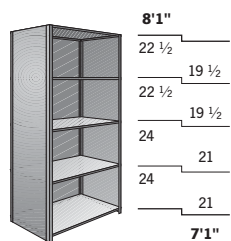

• Note: subtract 1 1/4" for clear opening height

Height	Width/Depth	Starter Unit			Adder Unit		
		Model No.	Wt. (lbs)	List (\$)	Model No.	Wt. (lbs)	List (\$)
7'1"	36 x 12	207053612	105.3	235.33	207053612A	98.1	217.51
	18	207053618	130.8	279.67	207053618A	119.1	254.34
	24	207053624	155.6	334.19	207053624A	139.5	299.02
8'1"	48 x 12	207054812	127.8	278.22	207054812A	120.6	260.40
	18	207054818	157.8	331.61	207054818A	146.1	306.28
	24	207054824	187.6	396.78	207054824A	171.5	361.62
	36 x 12	208053612	114.0	250.50	208053612A	105.7	230.30
	18	208053618	140.5	296.66	208053618A	127.2	268.04
	24	208053624	162.0	353.83	208053624A	146.0	314.05
48 x 12	18	208054812	138.6	296.81	208054812A	130.3	276.60
	18	208054818	169.6	352.01	208054818A	156.3	323.40
	24	208054824	199.7	419.85	208054824A	182.3	380.06

Angle Post 6

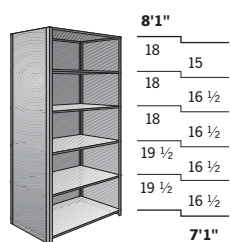

• Note: subtract 1 1/4" for clear opening height

7'1"	36 x 12	207063612	113.6	255.04	207063612A	106.4	237.22
	18	207063618	142.4	305.24	207063618A	130.7	279.92
	24	207063624	170.4	366.73	207063624A	154.3	331.56
48 x 12	18	207064812	138.7	303.23	207064812A	131.5	285.40
	18	207064818	172.9	364.29	207064818A	161.2	338.96
	24	207064824	206.9	438.56	207064824A	190.8	403.40
	36 x 12	208063612	122.3	270.21	208063612A	114.0	250.01
18	18	208063618	152.1	322.23	208063618A	138.8	293.62
	24	208063624	181.3	386.38	208063624A	163.0	346.59
	48 x 12	208064812	148.6	321.82	208064812A	140.3	301.61
18	18	208064818	183.8	384.70	208064818A	170.5	356.08
	24	208064824	219.0	461.63	208064824A	200.7	421.84

Angle Post 7

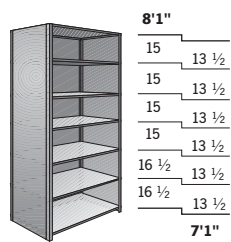

• Note: subtract 1 1/4" for clear opening height

7'1"	36 x 12	207073612	121.9	274.75	207073612A	114.7	256.93
	18	207073618	154.0	330.82	207073618A	142.3	305.50
	24	207073624	185.2	399.27	207073624A	169.1	364.11
48 x 12	18	207074812	149.6	328.24	207074812A	142.4	310.41
	18	207074818	188.0	396.97	207074818A	176.3	371.65
	24	207074824	226.2	480.34	207074824A	210.1	445.18
36 x 12	18	208073612	130.6	289.92	208073612A	122.3	269.72
	18	208073618	163.7	347.81	208073618A	150.4	319.20
	24	208073624	196.1	418.92	208073624A	177.8	379.14
48 x 12	18	208074812	159.5	346.82	208074812A	151.2	326.62
	18	208074818	198.9	417.38	208074818A	185.6	388.76
	24	208074824	238.3	503.41	208074824A	220.0	463.62

Angle Post 8

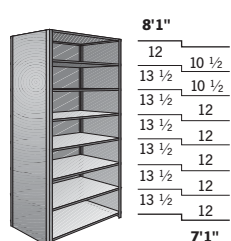

• Note: subtract 1 1/4" for clear opening height

7'1"	36 x 12	207083612	130.2	294.46	207083612A	123.0	276.64
	18	207083618	165.6	356.40	207083618A	153.9	331.07
	24	207083624	200.0	431.82	207083624A	183.9	396.65
48 x 12	18	207084812	160.5	353.24	207084812A	153.3	335.41
	18	207084818	203.1	429.65	207084818A	191.4	404.33
	24	207084824	245.5	522.12	207084824A	229.4	486.96
36 x 12	18	208083612	138.9	309.63	208083612A	130.6	289.43
	18	208083618	175.3	373.39	208083618A	162.0	344.77
	24	208083624	210.9	451.47	208083624A	192.6	411.68
48 x 12	18	208084812	170.4	371.83	208084812A	162.1	351.62
	18	208084818	214.0	450.06	208084818A	200.7	421.45
	24	208084824	257.6	545.19	208084824A	239.3	468.96

www.southwestsolutions.com

Toll Free 1-800-803-1083

Closed Shelving

	Starter Unit			Adder Unit		
	Angle Post	Delta Post	Beaded Post	Angle Post	Delta Post	Beaded Post
Posts (front)	(2) Angle	(2) Delta	(2) Beaded	(2) Angle	(1) Delta	(1) Beaded
Posts (rear)	(2) Angle	(2) Angle	(2) Angle	(2) Angle	(2) Angle	(2) Angle
Side Panels (each)	2	2	2	1	1	1
Back Panels (each)	1	1	1	1	1	1
Base Strips (each)	1	1	1	1	1	1

Note: Back and side panel are supplied as 2 or more pieces.

Clip Shelving – Standard Closed Units (Class 1 Shelves)

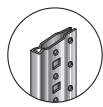

Shelves/Unit	Height	Width/Depth	Starter Unit			Adder Unit		
			Model No.	Wt. (lbs)	List (\$)	Model No.	Wt. (lbs)	List (\$)
Delta Post 5	7'1"	36 x 12	407053612	107.5	241.94	407053612A	94.8	210.14
			407053618	133.0	286.27	407053618A	115.0	268.31
			407053624	157.8	362.13	407053624A	135.4	291.65
		48 x 12	407054812	130.0	284.83	407054812A	116.5	253.03
			407054818	160.0	338.21	407054818A	142.0	298.92
			407054824	189.8	403.39	407054824A	167.4	354.25
	8'1"	36 x 12	408053612	116.6	257.89	408053612A	101.1	221.84
			408053618	143.1	304.04	408053618A	122.6	259.59
			408053624	169.1	361.22	408053624A	143.6	305.59
		48 x 12	408054812	141.2	304.19	408054812A	125.7	268.15
			408054818	172.2	359.40	408054818A	151.7	314.94
			408054824	203.2	427.23	408054824A	177.7	371.61
Delta Post 6	7'1"	36 x 12	407063612	124.8	261.65	407063612A	106.8	229.85
			407063618	144.6	311.85	407063618A	126.6	272.55
			407063624	172.6	373.33	407063624A	150.2	324.20
		48 x 12	407064812	149.9	309.83	407064812A	131.9	278.04
			407064818	175.1	370.89	407064818A	157.1	331.60
			407064824	209.1	445.17	407064824A	186.7	396.03
	8'1"	36 x 12	408063612	124.9	277.60	408063612A	109.4	241.55
			408063618	154.7	329.62	408063618A	134.2	285.16
			408063624	183.9	393.76	408063624A	158.4	338.14
		48 x 12	408064812	151.2	329.20	408064812A	135.7	293.15
			408064818	186.4	392.08	408064818A	165.9	347.63
			408064824	221.6	469.01	408064824A	196.1	413.39
Delta Post 7	7'1"	36 x 12	407073612	124.1	281.36	407073612A	110.6	249.56
			407073618	156.2	337.42	407073618A	138.2	298.13
			407073624	187.4	405.88	407073624A	165.0	356.74
		48 x 12	407074812	151.8	334.84	407074812A	138.3	303.04
			407074818	190.2	403.57	407074818A	172.2	364.28
			407074824	228.4	486.95	407074824A	206.0	437.81
	8'1"	36 x 12	408073612	133.2	297.31	408073612A	117.7	261.26
			408073618	166.3	355.19	408073618A	145.8	310.74
			408073624	194.3	426.30	408073624A	171.0	370.68
		48 x 12	408074812	162.1	354.20	408074812A	146.6	318.16
			408074818	201.5	424.76	408074818A	181.0	380.31
			408074824	240.9	510.79	408074824A	215.4	455.17
Delta Post 8	7'1"	36 x 12	407083612	132.4	301.07	407083612A	118.9	269.27
			407083618	167.8	363.00	407083618A	149.8	323.71
			407083624	202.2	438.42	407083624A	179.8	389.28
		48 x 12	407084812	162.7	359.84	407084812A	149.2	328.05
			407084818	205.3	436.26	407084818A	187.3	396.96
			407084824	247.7	528.73	407084824A	225.3	479.59
	8'1"	36 x 12	408083612	134.6	317.02	408083612A	120.9	280.97
			408083618	168.4	380.77	408083618A	150.7	336.32
			408083624	200.8	458.85	408083624A	179.0	403.22
		48 x 12	408084812	163.9	379.21	408084812A	152.2	343.17
			408084818	205.6	457.44	408084818A	187.9	412.99
			408084824	247.3	552.57	408084824A	225.6	496.95

- Delta in front only; Angle Posts at rear
- Note: subtract 1 1/4" for clear opening height

- Delta in front only; Angle Posts at rear
- Note: subtract 1 1/4" for clear opening height

- Delta in front only; Angle Posts at rear
- Note: subtract 1 1/4" for clear opening height

- Delta in front only; Angle Posts at rear
- Note: subtract 1 1/4" for clear opening height

www.southwestsolutions.com

Toll Free 1-800-803-1083

10

Model Number Explanation

1	07	08	36	12	A
Type of Unit	Nominal Height (ft.)	No. of Shelves	Width (in.)	Depth (in.)	Adder Unit (optional)

Types of Units

- | | |
|-------------------------------------|--------------------------------------|
| 1 Open, Angle Post | 5 Open, Beaded Post (front) |
| 2 Closed, Angle Post | 6 Closed, Beaded Post (front) |
| 3 Open, Delta Post (front) | LD Light Duty |
| 4 Closed, Delta Post (front) | |

Hardware included with Closed Units:

- Nuts and bolts for top and bottom shelves
- Clips for intermediate shelves (optional for top and bottom)
- Closed Base Strips

Clip Shelving – Standard Closed Units (Class 1 Shelves)

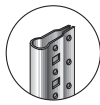

Beaded Post 5

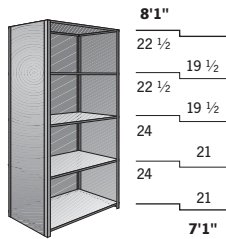

- Beaded in front only; Angle Posts at rear
- Note: subtract 1 1/4" for clear opening height

Beaded Post 6

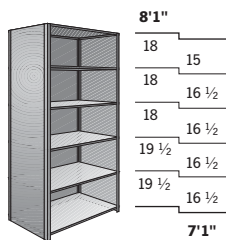

- Beaded in front only; Angle Posts at rear
- Note: subtract 1 1/4" for clear opening height

Beaded Post 7

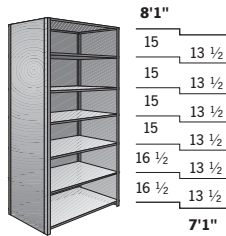

- Beaded in front only; Angle Posts at rear
- Note: subtract 1 1/4" for clear opening height

Beaded Post 8

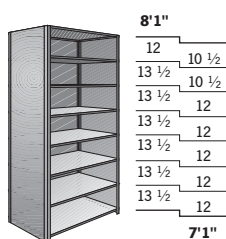

- Beaded in front only; Angle Posts at rear
- Note: subtract 1 1/4" for clear opening height

Shelves/Unit	Height	Width/Depth	Starter Unit			Adder Unit		
			Model No.	Wt. (lbs)	List (\$)	Model No.	Wt. (lbs)	List (\$)
5	7'1"	36 x 12	607053612	117.1	258.29	607053612A	98.8	218.32
		18	607053618	142.6	307.15	607053618A	127.0	259.82
		24	607053624	167.4	360.56	607053624A	140.2	301.98
5	8'1"	48 x 12	607054812	139.6	300.69	607054812A	121.3	261.27
		18	607054818	169.6	365.30	607054818A	154.0	317.97
		24	607054824	199.4	429.49	607054824A	172.2	370.90
5	8'1"	36 x 12	608053612	127.4	274.41	608053612A	106.5	229.39
		18	608053618	153.9	331.49	608053618A	128.0	275.70
		24	608053624	179.9	387.49	608053624A	149.0	320.93
5	8'1"	48 x 12	608054812	152.0	327.39	608054812A	131.1	282.38
		18	608054818	183.0	394.17	608054818A	157.1	338.38
		24	608054824	214.0	460.94	608054824A	183.1	394.38

6	7'1"	36 x 12	607063612	125.4	270.10	607063612A	107.1	230.69
		18	607063618	154.2	328.20	607063618A	131.4	280.73
		24	607063624	182.2	392.44	607063624A	155.0	333.86
6	8'1"	48 x 12	607064812	150.5	324.16	607064812A	132.2	284.75
		18	607064818	184.7	397.83	607064818A	161.9	350.49
		24	607064824	218.7	471.06	607064824A	191.5	412.47
6	8'1"	36 x 12	608063612	135.7	292.29	608063612A	114.8	247.27
		18	608063618	165.5	356.47	608063618A	139.6	300.69
		24	608063624	194.7	419.37	608063624A	163.8	352.81
6	8'1"	48 x 12	608064812	162.9	350.87	608064812A	142.0	305.86
		18	608064818	198.1	426.69	608064818A	172.2	370.90
		24	608064824	233.4	487.66	608064824A	202.4	422.71

7	7'1"	36 x 12	607073612	133.7	287.98	607073612A	115.4	248.56
		18	607073618	165.8	353.78	607073618A	143.0	306.31
		24	607073624	197.0	424.32	607073624A	169.8	365.73
7	8'1"	48 x 12	607074812	161.4	347.64	607074812A	143.1	308.23
		18	607074818	199.8	419.93	607074818A	177.0	372.46
		24	607074824	238.0	512.63	607074824A	210.8	454.04
7	8'1"	36 x 12	608073612	144.0	310.16	608073612A	123.1	265.15
		18	608073618	177.1	381.46	608073618A	151.2	325.67
		24	608073624	209.5	451.24	608073624A	178.6	384.69
7	8'1"	48 x 12	608074812	173.8	374.35	608074812A	152.9	329.33
		18	608074818	213.2	459.21	608074818A	187.3	403.43
		24	608074824	252.6	544.08	608074824A	221.7	477.52

8	7'1"	36 x 12	607083612	142.0	317.42	607083612A	123.7	277.45
		18	607083618	177.4	379.35	607083618A	154.6	331.88
		24	607083624	211.8	456.20	607083624A	184.6	397.61
8	8'1"	48 x 12	607084812	172.3	371.12	607084812A	154.0	331.70
		18	607084818	214.9	452.61	607084818A	192.1	405.14
		24	607084824	257.3	554.20	607084824A	230.1	495.61
8	8'1"	36 x 12	608083612	152.3	328.04	608083612A	131.4	283.02
		18	608083618	188.7	406.44	608083618A	162.8	350.66
		24	608083624	224.3	479.15	608083624A	193.4	414.20
8	8'1"	48 x 12	608084812	184.7	397.83	608084812A	163.8	352.81
		18	608084818	228.3	491.74	608084818A	202.4	435.95
		24	608084824	271.9	571.22	608084824A	241.0	507.04

www.southwestsolutions.com

Toll Free 1-800-803-1083

Closed Shelving	Starter Unit			Adder Unit		
	Angle Post	Delta Post	Beaded Post	Angle Post	Delta Post	Beaded Post
Posts (front)	(2) Angle	(2) Delta	(2) Beaded	(2) Angle	(1) Delta	(1) Beaded
Posts (rear)	(2) Angle	(2) Angle	(2) Angle	(2) Angle	(2) Angle	(2) Angle
Side Panels (each)	2	2	2	1	1	1
Back Panels (each)	1	1	1	1	1	1
Base Strips (each)	1	1	1	1	1	1

Note: Back and side panel are supplied as 2 or more pieces.

Light Duty Open Units (Class 0 Shelves)

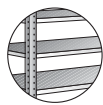

Shelves/Unit

5

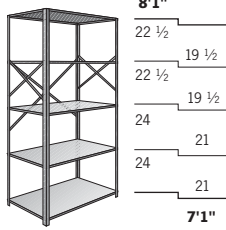

• Note: subtract 1 1/4" for clear opening height

Height

7'1"

Width/Depth

36 x **12**
15
18
24

48 x **12**
15
18
24

8'1"

36 x **12**
15
18
24

48 x **12**
15
18
24

Starter Unit

Model No. Wt. (lbs) List (\$)

LD07053612	56.7	137.88
•• LD07053615	62.1	147.14
LD07053618	69.6	164.26
LD07053624	82.0	193.31
LD07054812	67.0	158.75
•• LD07054815	75.4	178.65
LD07054818	83.4	199.91
LD07054824	100.7	230.62
LD08053612	59.5	140.98
•• LD08053615	64.9	153.77
LD08053618	72.7	170.17
LD08053624	85.2	201.87
LD08054812	69.8	165.38
•• LD08054815	78.2	185.28
LD08054818	86.2	204.24
LD08054824	103.5	245.22

Adder Unit

Model No. Wt. (lbs) List (\$)

LD07053612A	55.7	135.49
•• LD07053615A	60.9	144.29
LD07053618A	68.4	160.45
LD07053624A	80.8	189.51
LD07054812A	66.0	156.38
•• LD07054815A	74.2	175.80
LD07054818A	82.2	196.10
LD07054824A	99.1	226.81
LD08053612A	58.5	138.61
•• LD08053615A	63.0	150.93
LD08053618A	71.2	166.37
LD08053624A	83.6	198.08
LD08054812A	68.8	163.01
•• LD08054815A	77.0	182.44
LD08054818A	85.0	201.39
LD08054824A	101.9	241.43

Angle Posts

6

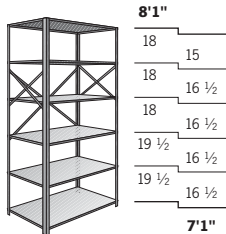

• Note: subtract 1 1/4" for clear opening height

7'1"

36 x **12**
15
18
24

48 x **12**
15
18
24

8'1"

36 x **12**
15
18
24

48 x **12**
15
18
24

LD07063612	63.0	154.60
•• LD07063615	69.4	164.43
LD07063618	78.4	185.68
LD07063624	93.2	220.55
LD07064812	75.2	178.17
•• LD07064815	85.2	201.87
LD07064818	94.8	224.61
LD07064824	115.4	273.42
LD08063612	65.8	160.55
•• LD08063615	72.2	171.07
LD08063618	81.2	191.60
LD08063624	96.0	226.46
LD08064812	78.0	184.81
•• LD08064815	88.0	208.50
LD08064818	97.6	233.98
LD08064824	118.2	270.83

LD07063612A	62.0	152.21
•• LD07063615A	68.2	161.59
LD07063618A	77.2	181.88
LD07063624A	92.0	216.74
LD07064812A	74.2	174.67
•• LD07064815A	84.0	199.02
LD07064818A	93.6	219.92
LD07064824A	113.8	268.73
LD08063612A	64.8	158.16
•• LD08063615A	71.0	168.22
LD08063618A	80.0	187.79
LD08063624A	94.8	222.66
LD08064812A	77.0	182.44
•• LD08064815A	86.8	205.66
LD08064818A	96.4	230.17
LD08064824A	116.6	267.02

Angle Posts

7

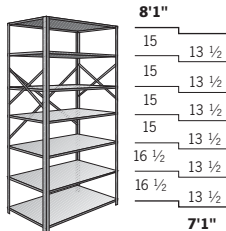

• Note: subtract 1 1/4" for clear opening height

7'1"

36 x **12**
15
18
24

48 x **12**
15
18
24

8'1"

36 x **12**
15
18
24

48 x **12**
15
18
24

LD07073612	69.3	171.32
•• LD07073615	76.7	181.73
LD07073618	87.2	207.11
LD07073624	104.4	247.78
LD07074812	83.4	197.60
•• LD07074815	95.0	225.09
LD07074818	106.2	256.22
LD07074824	130.1	308.25
LD08073612	72.1	170.83
•• LD08073615	79.5	188.36
LD08073618	90.0	213.24
LD08073624	107.2	253.99
LD08074812	86.2	204.24
•• LD08074815	97.8	231.72
LD08074818	109.0	258.26
LD08074824	132.9	314.88

LD07073612A	68.3	168.93
•• LD07073615A	75.5	178.88
LD07073618A	86.0	203.30
LD07073624A	103.2	243.98
LD07074812A	82.4	194.10
•• LD07074815A	93.8	222.24
LD07074818A	105.0	252.42
LD07074824A	128.5	303.56
LD08073612A	71.1	168.46
•• LD08073615A	78.3	185.52
LD08073618A	88.8	210.40
LD08073624A	106.0	250.19
LD08074812A	85.2	201.87
•• LD08074815A	96.6	228.88
LD08074818A	107.8	255.41
LD08074824A	131.3	311.09

www.southwestsolutions.com

Toll Free 1-800-803-1083

12

Model Number Explanation

1	07	08	36	12	A
Type of Unit	Nominal Height (ft.)	No. of Shelves	Width (in.)	Depth (in.)	Adder Unit (optional)

Types of Units

- 1 Open, Angle Post
- 2 Closed, Angle Post
- 3 Open, Delta Post (front)
- 4 Closed, Delta Post (front)
- 5 Open, Beaded Post (front)
- 6 Closed, Beaded Post (front)
- LD Light Duty

- Non-stock items
- Low stock items

Hardware included with Light Duty units:

- Nuts and bolts for top and bottom shelves
- Clips for intermediate shelves (optional for top and bottom)

Light Duty Open Units (Class 0 Shelves)

Shelves/Unit
Angle Posts **8**

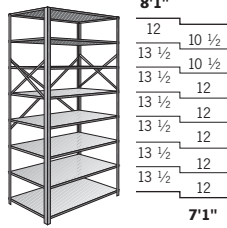

• Note: subtract 1 1/4" for clear opening height

Shelves/Unit	Height	Width/Depth	Starter Unit			Adder Unit			
			Model No.	Wt. (lbs)	List (\$)	Model No.	Wt. (lbs)	List (\$)	
8	7'1"	36 x 12	LD07083612	75.6	188.03	LD07083612A	74.6	185.64	
			•• LD07083615	84.0	199.02	•• LD07083615A	82.8	196.18	
			LD07083618	96.0	230.34	LD07083618A	94.8	224.73	
			LD07083624	115.6	273.89	LD07083624A	114.4	269.20	
	8'1"	48 x 12	LD07084812	91.6	222.65	LD07084812A	90.6	220.26	
			•• LD07084815	104.8	248.30	•• LD07084815A	103.6	245.46	
			LD07084818	117.6	284.38	LD07084818A	116.4	280.57	
			LD07084824	144.0	333.52	LD07084824A	142.8	329.71	
	8	7'1"	36 x 12	LD08083612	78.4	185.76	LD08083612A	77.4	183.39
				•• LD08083615	86.8	205.66	•• LD08083615A	85.6	202.81
				LD08083618	98.8	234.09	LD08083618A	97.6	231.25
				LD08083624	118.8	281.47	LD08083624A	117.2	277.68
8'1"		48 x 12	LD08084812	94.6	224.14	LD08084812A	93.4	221.29	
			•• LD08084815	107.6	254.94	•• LD08084815A	106.4	252.10	
			LD08084818	120.4	285.26	LD08084818A	119.2	282.42	
			LD08084824	147.6	349.71	LD08084824A	146.0	345.92	

Bin Units (Class 1 Shelves)

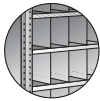

Bin Units
Openings **21**

Bin Units	Openings	Height	Width/Depth	Starter Unit			Adder Unit		
				Model No.	Wt. (lbs)	List (\$)	Model No.	Wt. (lbs)	List (\$)
Bin Units	21	7'1"	36 x 12	•• 2D-1208	150.6	389.96	•• 2D-1208A	143.4	372.14
				•• 2D-1808	196.8	481.75	•• 2D-1808A	185.1	456.42
				•• 2D-2408	243.4	582.23	•• 2D-2408A	227.3	547.07
	36	7'1"	36 x 12	•• 3D-1210	179.2	507.54	•• 3D-1210A	172.0	489.71
				•• 3D-1810	237.4	627.63	•• 3D-1810A	225.7	602.31
				•• 3D-2410	297.1	761.36	•• 3D-2410A	281.0	726.19
	54	7'1"	36 x 12	•• 5D-1210	200.8	623.31	•• 5D-1210A	193.6	605.48
				•• 5D-1810	269.8	821.83	•• 5D-1810A	258.1	796.08
				•• 5D-2410	342.1	1,042.81	•• 5D-2410A	326.0	1,007.01
	78	7'1"	36 x 12	•• 5D-1214	252.0	762.34	•• 5D-1214A	244.8	744.51
				•• 5D-1814	358.2	1,091.11	•• 5D-1814A	364.5	1,065.36
				•• 5D-2414	457.3	1,130.86	•• 5D-2414A	441.2	1,095.69

- Dividers ship with clips for easy assembly
- Dividers are adjustable on 2" centers
- Available with Class 1 shelves and Angle Posts only

- Back and side panel are supplied as 2 or more pieces



21 Openings

(18) 12" w x 12" h
(3) 12" w x 9" h

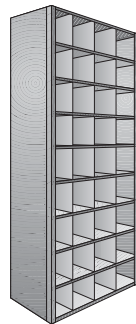

36 Openings

(36) 9" w x 9" h



54 Openings

(54) 6" w x 9" h



78 Openings

(72) 6" w x 6" h
(6) 6" w x 9" h

Note: subtract 1 1/4" (shelf profile) for true opening height

Multi-level Systems

Consult our Engineering Department for solutions for your catwalk, mezzanine and highrise applications.

Our designs meet OSHA, UBC, and seismic requirements. Engineered calculations and stamped drawings for permit applications are available.

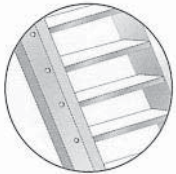
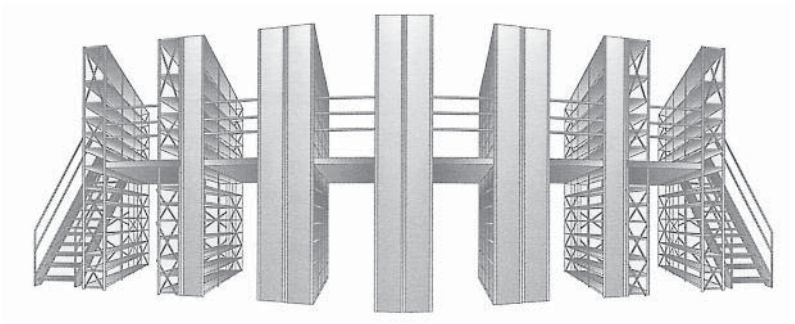

Stairs

- Made to UBC and OSHA specifications
- Available in knock-down or all welded
- Open and closed risers
- Handicap end loops available; welded or KD as required



Standard Return / Double Return

- Sold as knock-down unit
- 3 rail guardrail included
- Decking is 9" metal plank
- C-channel frame with 4 columns
- Landings over 12' tall include center strut bracing
- Stairs over 12' tall require an intermediate landing
- **Standard return shown**



Handrail - Gates

- Standard or public access
- End of aisle
- Gates lift out, swing, and slide

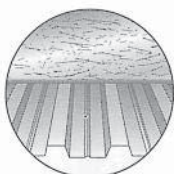

Decking Options

- 3/4" or 1 1/8" Deck Pak over B Deck
- Bar Grating
- Grating Pak
- Plank - Pak
- Diamond Plate

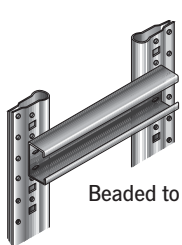

Beaded to Beaded



Beaded to Angle

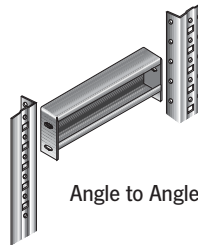

Angle to Angle

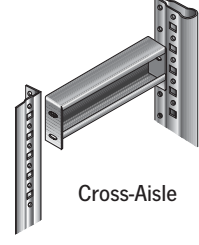

Cross-Aisle

	Length	Model No.	Wt. (lbs)	List (\$)
Beaded to Beaded Post	36	• ADS-B-B-36	8.5	17.60
	45	• ADS-B-B-45	10.4	22.11
	48	• ADS-B-B-48	10.5	21.93
Angle to Angle Post	36	• ADS-A-A-36	7.6	27.49
	45	• ADS-A-A-45	9.5	31.65
	48	• ADS-A-A-48	10.1	32.12

	Length	Model No.	Wt. (lbs)	List (\$)
Beaded to Angle Post	36	• ADS-B-A-36	8.0	26.18
	45	• ADS-B-A-45	10.0	32.23
	48	• ADS-B-A-48	10.5	33.88
Cross-Aisle (Beaded to Beaded/Angle)	36	• ADS-A-A-36	7.6	27.49
	45	• ADS-A-A-45	9.5	31.65
	48	• ADS-A-A-48	10.1	32.12

Accessories and Components

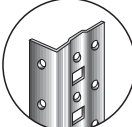
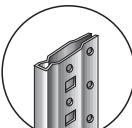
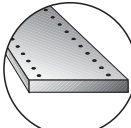
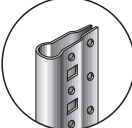
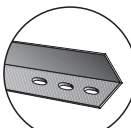
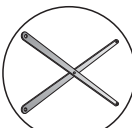
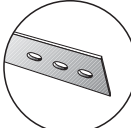
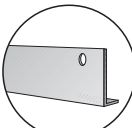
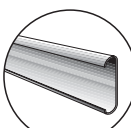
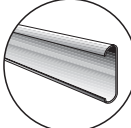
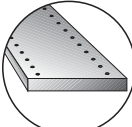
	Size (inches)	Model No.	Wt. (lbs)	List (\$)		Size (inches)	Model No.	Wt. (lbs)	List (\$)	
Angle Posts 	Height	40	•• CP040	2.4	5.10	42 x 12	•• SH4212	9.6	22.37	
		61	•• CP061	3.7	7.70	15	•• SH4215	11.5	26.26	
		73	CP073	4.4	9.18	18	•• SH4218	13.3	29.14	
		85	CP085	5.2	10.67	24	•• SH4224	17.1	37.14	
		88	•• CP088	5.4	11.04	30	•• SH4230	20.8	47.69	
		97	CP097	5.9	12.15	32	•• SH4232	22.0	48.52	
		109	•• CP109	6.6	13.65	36	•• SH4236	24.5	54.00	
		121	•• CP121	7.3	15.10	48 x 12	SH4812	10.9	25.01	
		145	•• CP145	8.8	20.51	15	•• SH4815	13.0	29.43	
		181	• CP181	11.0	27.02	18	SH4818	15.1	32.69	
Delta Posts 	Height	61	•• DP061	4.5	10.09	Standard Shelves	36 x 12	•• SH03612	6.3	16.72
		73	DP073	5.4	12.02	(20 gauge)	15	•• SH03615	7.9	19.51
		85	DP085	6.3	13.97		18	SH03618	8.8	21.43
		88	•• DP088	6.5	14.39	• clips included	24	SH03624	11.2	27.24
		97	DP097	7.2	15.84	42 x 12	• SH04212	7.3	18.92	
		109	•• DP109	8.1	17.77	15	• SH04215	8.7	22.83	
		121	•• DP121	9.0	19.76	18	• SH04218	10.1	24.35	
Beaded Posts 	Height	61	•• BP061	8.0	15.95	24	• SH04224	12.9	31.01	
		73	BP073	9.5	19.05	48 x 12	•• SH04812	8.2	20.80	
		85	BP085	11.1	22.15	15	• SH04815	9.8	25.53	
		88	•• BP088	11.5	22.83	18	•• SH04818	11.4	28.16	
		97	BP097	12.6	25.17	24	•• SH04824	14.7	34.30	
		109	• BP109	14.3	28.27	Shelf Reinforcing Angle	18	• RA18	.9	3.13
		121	•• BP121	15.7	31.35		24	• RA24	1.2	3.73
		145	•• BP145	18.9	37.54	30	•• RA30	1.5	4.36	
		181	BP181	23.5	48.53	36	RA36	1.8	4.98	
Sway Braces 	Length	17	SB12/15	1.0	2.39	42	•• RA42	2.0	5.62	
		29	SB18/24	1.6	3.81	48	RA48	2.4	6.21	
		41	•• SB30	2.1	6.32	Shelf Reinforcing Bar	30	•• RB30	.8	2.55
		45	SB32/36	2.4	6.85		36	RB36	1.0	2.93
		58	SB42/48	3.0	8.83	42	•• RB42	1.2	3.31	
						48	RB48	1.4	3.67	
Closed Base Strips 	1 1/2 x 36	•• CB361	1.4	4.50	Label Holders	30	•• LH30	.3	3.13	
		42	•• CB421	1.7	5.09		36	•• LH36	.4	3.33
		48	•• CB481	1.9	5.59	42	•• LH42	.5	3.52	
		3 x 30	• CB303	1.8	5.39	48	•• LH48	.6	3.78	
		36	CB363	2.2	6.13	Welded End Upright Assembly	12 x 73	• DEA12073	15.8	58.57
		42	•• CB423	2.5	6.96	(Delta Post)	85	• DEA12085	18.7	65.31
		48	CB483	2.9	7.79		88	• DEA12088	19.4	66.45
Standard Shelves (18 gauge) 	30 x 12	•• SH3012	7.1	17.19	97	• DEA12097	21.4	68.33		
	15	•• SH3015	8.4	20.04	109	• DEA12109	22.7	86.08		
	18	•• SH3018	9.8	22.16	121	• DEA12121	24.9	93.55		
	24	•• SH3024	12.5	27.97						
	30	•• SH3030	15.2	38.71						
	36	• SH3036	17.9	41.64						
	36 x 12	SH3612	8.3	19.71						
	15	•• SH3615	10.0	23.09						
	18	SH3618	11.6	25.58						
	24	SH3624	14.8	32.55						
	30	•• SH3630	18.0	41.70						
	36	•• SH3636	21.2	48.90						

Accessories and Components

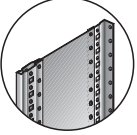
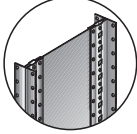
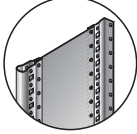
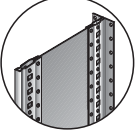
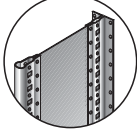
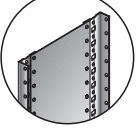
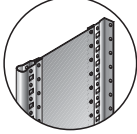
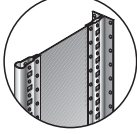
				Size (inches)	Model No.	Wt. (lbs)	List (\$)					Size (inches)	Model No.	Wt. (lbs)	List (\$)		
Welded End Upright Assembly (Delta Post) 	15 x 73	•	DEA15073	17.9	63.12			24 x 73	•	AEA24073	22.6	73.57					
		•	DEA15085	20.9	69.70				85	•	AEA24085	26.5	81.42				
		•	DEA15088	21.6	72.16				88	•	AEA24088	28.4	81.65				
		•	DEA15097	23.9	74.68				97	•	AEA24097	30.1	88.35				
		•	DEA15109	26.0	85.04				109	•	AEA24109	32.2	103.03				
	•	DEA15121	28.5	94.23	121			•	AEA24121	35.6	119.73						
	18 x 73	•	DEA18073	19.8	66.71			Welded Intermediate Upright Assembly (Angle Post) 		12 x 73	•	AIA12073	23.6	66.70			
		•	DEA18085	23.2	71.67						85	•	AIA12085	28.0	80.45		
		•	DEA18088	24.0	73.58						88	•	AIA12088	29.0	82.87		
		•	DEA18097	26.4	78.72						97	•	AIA12097	31.9	88.30		
		•	DEA18109	28.9	95.45						109	•	AIA12109	31.1	90.57		
	•	DEA18121	31.6	104.75	121					•	AIA12121	34.2	96.73				
	24 x 73	•	DEA24073	23.6	76.43					Welded End Upright Assembly (Beaded Post) 		15 x 73	•	AIA15073	25.7	70.16	
		•	DEA24085	27.6	84.60								85	•	AIA15085	30.2	82.43
		•	DEA24088	28.5	86.01								88	•	AIA15088	31.3	85.33
•		DEA24097	31.4	92.13	97	•	AIA15097						34.4	94.52			
•		DEA24109	34.8	121.18	109	•	AIA15109						36.3	99.16			
•	DEA24121	37.9	124.44	121	•	AIA15121	37.8					103.17					
Welded Intermediate Upright Assembly (Delta Post) 	12 x 73	•	DIA12073	20.2	69.64							18 x 73	•	AIA18073	27.6	79.89	
		•	DIA12085	23.9	76.50								85	•	AIA18085	32.5	88.29
		•	DIA12088	24.7	79.20								88	•	AIA18088	33.6	90.79
		•	DIA12097	27.3	81.71			97	•				AIA18097	36.9	100.19		
		•	DIA12109	28.1	87.11			109	•				AIA18109	37.3	102.41		
	•	DIA12121	30.9	96.03	121			•	AIA18121			40.9	110.00				
	15 x 73	•	DIA15073	22.3	69.78			Welded Intermediate Upright Assembly (Beaded Post) 				24 x 73	•	AIA24073	31.4	84.43	
		•	DIA15085	26.1	82.36								85	•	AIA24085	36.9	102.48
		•	DIA15088	27.1	85.27								88	•	AIA24088	39.0	105.21
		•	DIA15097	29.8	93.09					97	•		AIA24097	41.9	111.72		
		•	DIA15109	31.4	95.24					109	•		AIA24109	43.2	131.99		
	•	DIA15121	34.5	104.75	121					•	AIA24121	47.2	147.55				
	18 x 73	•	DIA18073	24.2	77.78					Welded End Upright Assembly (Angle Post) 		12 x 73	•	BEA12073	19.9	63.98	
		•	DIA18085	28.4	83.89								85	•	BEA12085	23.5	71.25
		•	DIA18088	29.4	86.09								97	•	BEA12097	26.8	78.52
•		DIA18097	32.3	92.10	109	•	BEA12109						28.8	91.58			
•		DIA18109	34.4	99.86	121	•	BEA12121						31.7	105.03			
•	DIA18121	37.7	126.24	15 x 73	•	BEA15073	22.0					70.06					
•	DIA24073	28.0	88.14		85	•	BEA15085					25.7	74.86				
•	DIA24085	32.8	91.80		97	•	BEA15097					29.3	85.35				
•	DIA24088	33.9	95.64		109	•	BEA15109					32.1	98.34				
•	DIA24097	37.3	106.31		121	•	BEA15121	35.3	102.82								
•	DIA24109	40.1	118.06	18 x 73	•	BEA18073	23.9	72.39									
•	DIA24121	44.0	148.59		85	•	BEA18085	28.0	79.22								
•	AEA12073	14.8	55.71		97	•	BEA18097	31.8	87.89								
•	AEA12085	17.6	61.92		109	•	BEA18109	35.1	101.37								
•	AEA12088	18.2	63.74		121	•	BEA18121	38.5	116.27								
12 x 73	•	AEA12097	20.1	67.45	Welded End Upright Assembly (Beaded Post) 		24 x 73	•	BEA24073	27.7	83.37						
	•	AEA12097	20.1	67.45				85	•	BEA24085	32.4	92.77					
	•	AEA12109	20.4	70.13				97	•	BEA24097	36.8	101.30					
	•	AEA12109	20.4	70.13				109	•	BEA24109	40.9	117.58					
	•	AEA12121	22.1	78.53				121	•	BEA24121	58.8	135.92					
15 x 73	•	AEA15073	16.9	62.13			Welded Intermediate Upright Assembly (Beaded Post) 		12 x 73	•	BIA12073	24.3	78.33				
	•	AEA15085	19.8	65.88						85	•	BIA12085	28.7	83.48			
	•	AEA15088	20.5	67.19						97	•	BIA12097	32.7	96.45			
	•	AEA15097	22.6	73.66						109	•	BIA12109	34.3	108.64			
	•	AEA15109	23.5	84.62						121	•	BIA12121	37.8	126.52			
•	AEA15121	25.7	92.23	15 x 73					•	BIA15073	26.4	76.76					
•	AEA18073	18.8	64.46						85	•	BIA15085	30.9	89.31				
•	AEA18085	22.1	67.62						97	•	BIA15097	35.2	102.96				
•	AEA18088	22.9	69.80						109	•	BIA15109	37.6	115.26				
•	AEA18097	25.1	76.81						121	•	BIA15121	41.4	126.49				
•	AEA18109	26.4	79.92														
•	AEA18121	28.9	87.31														

Accessories and Components

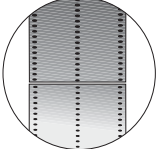
	Size (inches)	Model No.	Wt. (lbs)	List (\$)		Size (inches)	Model No.	Wt. (lbs)	List (\$)			
Welded Intermediate Upright Assembly (Beaded Post)	18 x 73	• BIA18073	28.3	83.46	42 x 88	• BA42088	31.9	64.24				
	85	• BIA18085	33.2	91.31		• BA42097	35.1	67.96				
	97	• BIA18097	37.7	101.27		109	• BA42109	40.9	83.40			
	109	• BIA18109	40.5	113.19		121	• BA42121	44.1	89.58			
	121	• BIA18121	44.3	137.76		48 x 40	• BA48040	16.9	32.34			
	24 x 73	• BIA24073	32.1	95.08			• BA48061	25.2	58.38			
		85	• BIA24085	37.6			105.79	• BA48073	30.8	58.38		
		97	• BIA24097	42.7			128.60	• BA48085	35.2	67.09		
		109	• BIA24109	46.4			136.17	• BA48088	36.3	71.05		
		121	• BIA24121	50.8			160.20	• BA48097	41.0	75.00		
End Panels	12 x 40	• SD12040	3.3	8.59	109	• BA48109	47.7	87.56				
		• SD12061	5.0	15.74		121	• BA48121	50.5	95.88			
		73	• SD12073	6.0	15.74	Full Shelf Dividers	12 d x 9 h	• DIV1209	1.2	6.44		
		85	• SD12085	7.2	17.83			12 h	• DIV1212	1.5	6.89	
		88	• SD12088	7.5	19.02		18 d x 9 h	• DIV1809	1.8	8.16		
		97	• SD12097	8.3	20.21			12 h	• DIV1812	2.3	9.09	
	109	• SD12109	9.2	23.61	16 ½ h			• DIV1816.5	3.1	11.04		
	121	• SD12121	10.0	25.85	18 h		• DIV1818	3.3	11.66			
	15 x 40	• SD15040	4.4	11.11	24 d x 9 h		• DIV2409	2.5	9.80			
		61	• SD15061	6.8			17.99	12 h	• DIV2412	3.2	10.91	
		73	• SD15073	8.1			17.99	18 h	• DIV2418	4.6	14.35	
		85	• SD15085	9.4			20.44	Sliding Dividers	12 d x 6 h	• SLD1206	1.6	8.10
		88	• SD15088	9.7			21.81			9 h	• SLD1209	2.1
		97	• SD15097	10.8		23.17	15 d x 6 h		• SLD1506	2.1	8.99	
		109	• SD15109	12.5	26.99	9 h			• SLD1509	2.6	9.84	
	121	• SD15121	13.5	29.58	18 d x 6 h	• SLD1806			2.5	9.95		
	18 x 40	• SD18040	5.5	12.05		9 h	• SLD1809	3.2	11.82			
		61	• SD18061	8.4	22.20	24 d x 6 h	• SLD2406	2.8	12.49			
		73	• SD18073	10.0	22.20		9 h	• SLD2409	4.3	14.09		
		85	• SD18085	11.7	25.33	Angle Dividers	12 d x 4 h	• AD1204	.8	4.64		
		88	• SD18088	12.1	26.97			6 h	• AD1206	1.1	5.57	
	97	• SD18097	13.3	28.62	9 h			• AD1209	1.6	6.94		
	109	• SD18109	15.5	33.29	15 d x 4 h		• AD1504	1.0	4.80			
	121	• SD18121	16.7	36.50			6 h	• AD1506	1.4	5.99		
	24 x 40	• SD24040	7.5	16.62			9 h	• AD1509	2.0	7.24		
61		• SD24061	11.5	30.65	18 d x 4 h		• AD1804	1.2	5.12			
73		• SD24073	13.8	30.65			6 h	• AD1806	1.6	6.48		
85		• SD24085	16.1	35.17	9 h		• AD1809	2.9	7.93			
88		• SD24088	17.3	37.48	24 d x 4 h		• AD2404	1.5	6.10			
97		• SD24097	18.3	39.79			6 h	• AD2406	2.1	7.76		
109	• SD24109	21.3	45.98	9 h		• AD2409	3.2	10.07				
121	• SD24121	23.0	50.55	Bin Fronts	1 ½ h x 36 w	• BF362	1.4	6.11				
30 x 40	• BA30040	10.5	21.46			3 h x 36 w	• BF363	1.8	8.08			
	61	• BA30061	15.5		41.71		1 ½ h x 42 w	• BF422	1.6	6.82		
	73	• BA30073	18.6		41.71	• BF423		2.0	9.11			
	85	• BA30085	22.0		45.40	2 h x 48 w		• BF482	1.8	7.38		
	88	• BA30088	23.6		47.39		3 h x 48 w	• BF483	2.3	9.92		
97	• BA30097	25.1	49.38		Back Panels			• Furnished in two pieces				
109	• BA30109	28.2	62.56									
121	• BA30121	31.1	66.39									
36 x 40	• BA36040	12.4	25.12									
	61	• BA36061	18.9	48.12								
	73	• BA36073	22.6	48.12								
	85	• BA36085	26.4	52.33								
	88	• BA36088	27.9	54.58								
	97	• BA36097	30.1	56.83								
109	• BA36109	35.0	72.18									
121	• BA36121	37.8	76.53									
42 x 40	• BA42040	14.4	29.03									
	61	• BA42061	22.1	55.60								
	73	• BA42073	26.4	55.60								
	85	• BA42085	30.8	60.53								

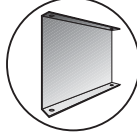

• Bolts or clips into place

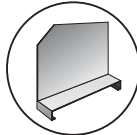

• Drops into place
• Not for use with bin front or closed base strip

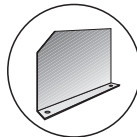



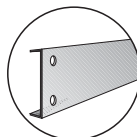



• Bolts or clips into place
• Not for use with bin front

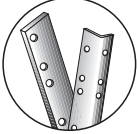

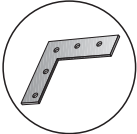
• Adapters sold separately

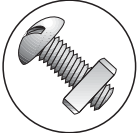
Accessories and Components

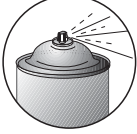
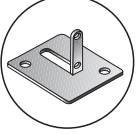
Size (inches)	Model No.	Wt. (lbs)	List (\$)	Size (inches)	Model No.	Wt. (lbs)	List(\$)		
Bin Front Adapter	3" Bin Front	HW1104	.1	0.90	Post Splice	Angle Post	HW1100	.3	2.99
	1 1/2" Bin Front	HW1104S	.1	0.79		Beaded Post	HW1105	.4	2.73
									
<ul style="list-style-type: none"> • Delta or Beaded Post 									
Shelf Clips		HW1103	.1	0.23	Corner Angle	HW1102	.1	1.93	
									
<ul style="list-style-type: none"> • Attaches shelf to post 				<ul style="list-style-type: none"> • Light loads only on angle posts 					
Divider and Label Holder Clips		HW1110	.02	0.08	Nuts and Bolts	1/2" bolt only	HW000165	1.8	0.24
									
<ul style="list-style-type: none"> • Attaches dividers or label holders to shelf 				<ul style="list-style-type: none"> • Per 100 • Sold separately 					
Utility Clips		UC	.05	0.24	Spray Touch-Up Paint	• • PT000470	1.0	31.35	
									
<ul style="list-style-type: none"> • For RivPak units 				<ul style="list-style-type: none"> • Available in gray, blue, beige or green 					
Foot Plates	standard	HW1109	.2	1.96					
	seismic	HW1109-S	.4	4.76					
									

Open Unit Assembly

- 1 Lay two Angle posts on floor or saw horses with 1" flange down. Bolt the top shelf to the sides of the posts in the top round hole (**Fig. 1**). Bolt the bottom shelf the same way using the third hole from the bottom of the post, or location where the bottom shelf will be required (3" max. from floor). Place right and left Angle, Beaded or Delta posts at front post locations as shown in (**Fig. 1**), then bolt from the sides. For 18-gauge shelves and non-seismic applications, clips may be used instead of bolts on top and bottom shelves. With top and bottom shelves bolted or clipped securely, stand the unit upright.
- 2 Install intermediate shelves using four clips per shelf. Shelves are adjustable on 1 1/2" centers using the square cutouts on the posts for clip attachment.
- 3 Attach the back sway brace (longer than the side sway braces) to the outside of the posts approximately 1/3 of the way between the top and bottom shelves (**Fig. 2**). Back to back units share a common sway brace.
- 4 Attach the side sway braces to the sides of the unit approximately 1/3 of the way between the top and bottom shelves (**Fig. 2**). For Beaded and Delta front posts, the side sway brace is placed between post flanges. When two or more units are bolted together side by side, the side sway brace is common between units. If installing Beaded or Delta post units, the Beaded or Delta post is common between units. Bolt centers of sway braces together.
- 5 Additional shelving units may be added to form a row by placing the side sway brace between 2 Angle posts, then proceeding to attach the adder unit(s) to the starter unit. If the bottom shelf must be less than 3" from floor to the bottom of shelf, then the top and bottom shelves should be attached while shelving unit is on its back (**Fig. 1**). For Beaded or Delta post adder units with the bottom shelf less than 3" from the floor, the top and bottom shelves must be attached (bolted) to the entire row before standing units upright.

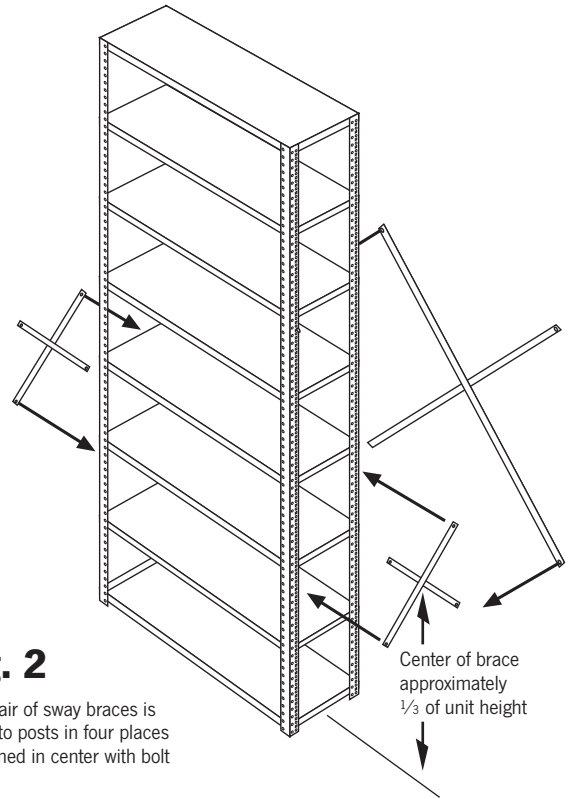

Fig. 2

Each pair of sway braces is bolted to posts in four places and joined in center with bolt

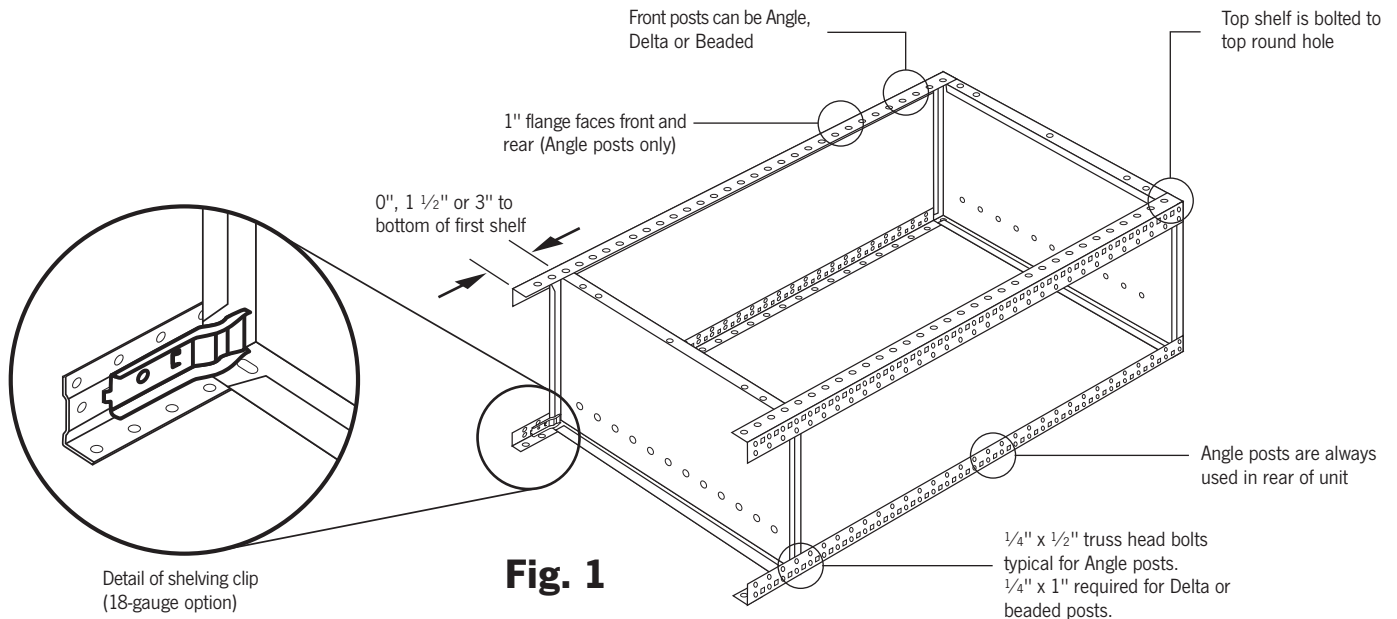

Fig. 1

Closed Unit Assembly

Note: For welded upright assemblies (end or intermediate), skip steps 1 and 2.

1 End upright assembly

End upright assembly requires one Angle post at the back and one Angle, Beaded or Delta post at the front. Bolt end panels inside the two posts as shown in **(Fig. 3)**. Nuts and bolts should be located approximately 18" apart. Panels are typically provided in 2 or more pieces and overlap a minimum of 1".

2 Intermediate upright assembly

Intermediate upright assembly requires two Angle posts at the back, and two Angle or one Beaded or Delta post at the front. Bolt the end panel between Angle posts or between rear flanges on Beaded or Delta post. Note: Before deciding where bolts should be located when attaching panels to posts, a sample unit may be built with all shelves in place to determine optimal location to prevent the bolts from interfering with the shelves.

3 Bolt the top shelf to the upright assemblies through the top round hole of the post **(Fig. 3)**. Bolt the bottom shelf to the upright using the third hole from the bottom of the post or other location where the bottom shelf will be required (3" max. from floor). Use two end upright assemblies if installing only one unit, or one end and one intermediate upright assembly if installing two or more units to form a row. For 18-gauge shelves and non-seismic applications, clips may be used instead of bolts on top and bottom shelves.

4 Install intermediate shelves using four clips per shelf. Shelves are adjustable on 1 1/2" centers using square cutouts on the posts for clip attachment.

5 Bolt the back panel to the back of the unit outside of the posts. If installing back to back units, the back panel should be placed between the units. Panels are typically provided in 2 or more pieces and overlap a minimum of 1".

6 Additional shelving units may be added to form a row by holding in position another intermediate upright assembly and repeating steps 3 through 5. For the last adder unit, use an end upright assembly instead of an intermediate assembly to finish the row.

7 If the bottom shelf must be less than 3" from the floor (to the bottom of the shelf), then the top and bottom shelves should be attached while the unit is on its back **(Fig. 3)**. For adder units using Delta or Beaded posts with the bottom shelf less than 3" from floor, the top and bottom shelves must be attached to entire row before standing units upright.

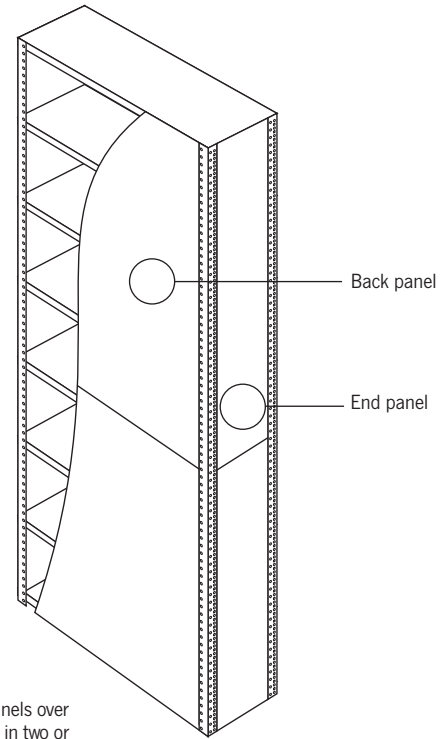

Fig. 4

End and back panels over 97" are supplied in two or more pieces

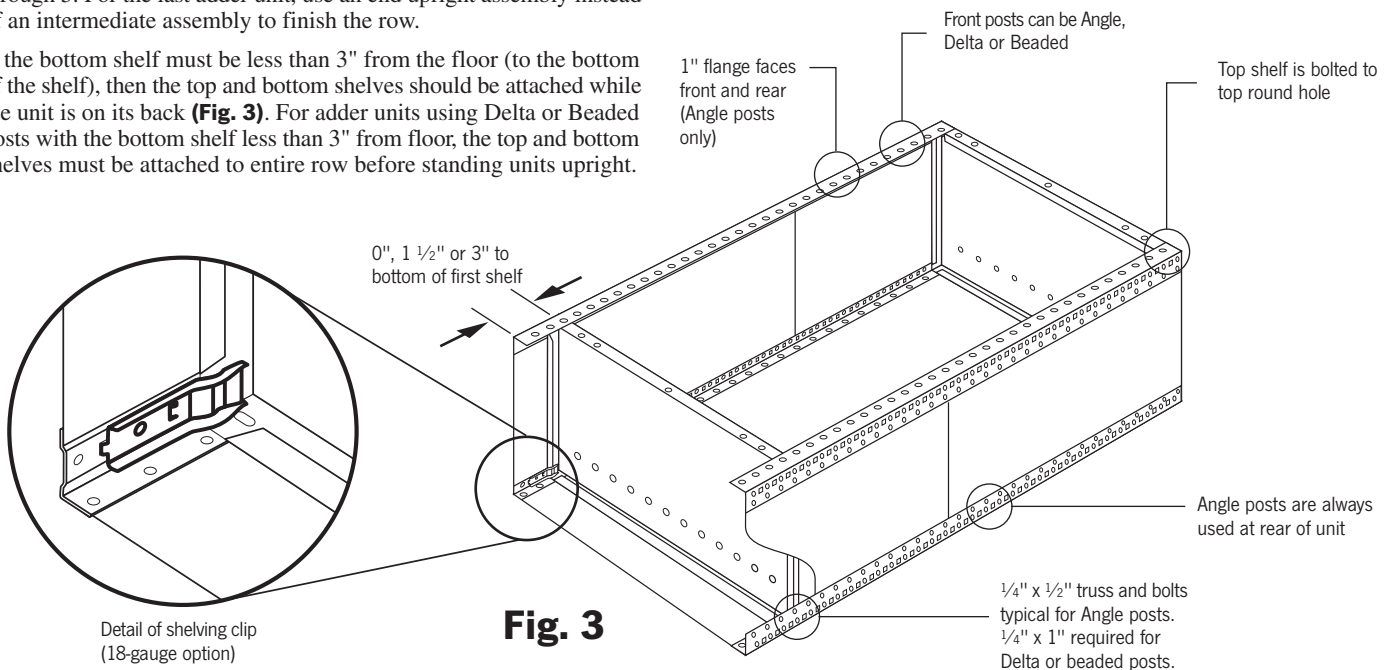
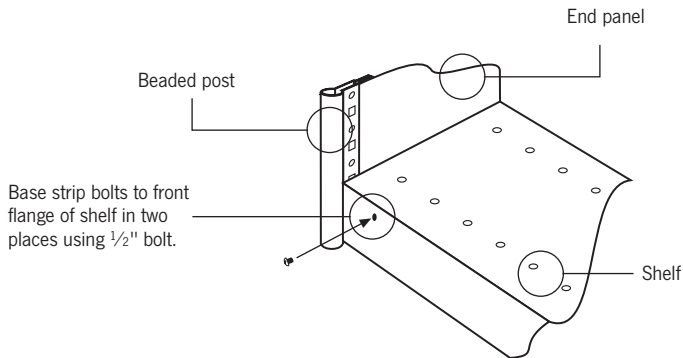
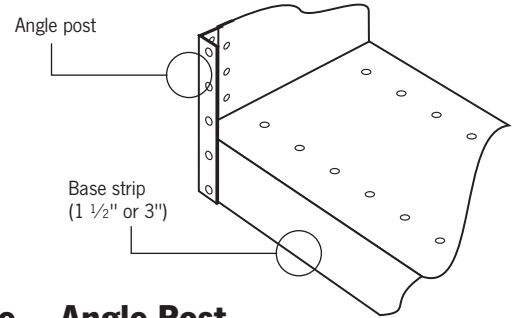

Fig. 3

Component Assembly



Closed Base – Beaded Post



Closed Base – Angle Post

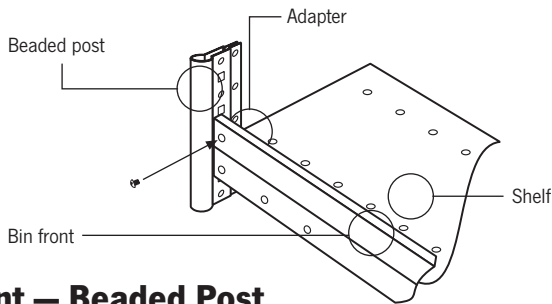

Bin Front – Beaded Post

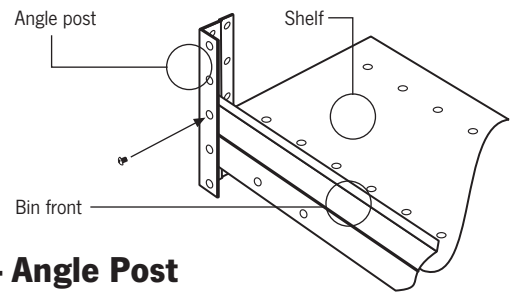

Bin Front – Angle Post

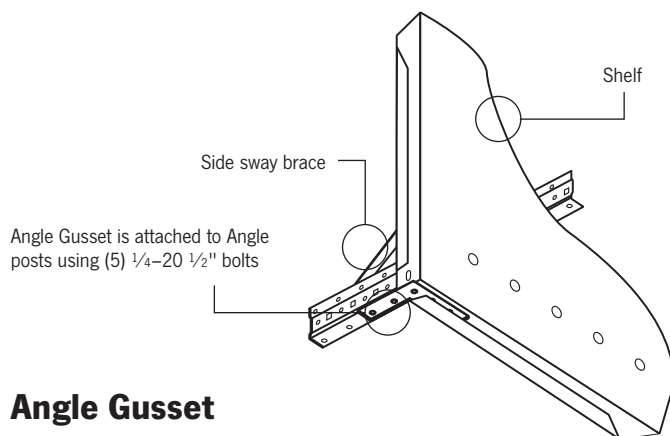

Angle Gusset

Angle Gussets may be used to replace back sway braces in light-duty applications. Use gussets on top, bottom, and one intermediate shelf (12 gussets needed per unit).

Gussets are for use with Angle posts only and are not recommended for units over 97" high.

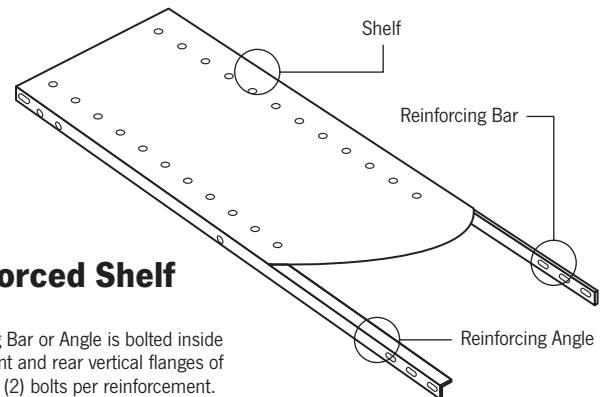

Reinforced Shelf

Reinforcing Bar or Angle is bolted inside front or front and rear vertical flanges of shelf using (2) bolts per reinforcement.

Component Assembly

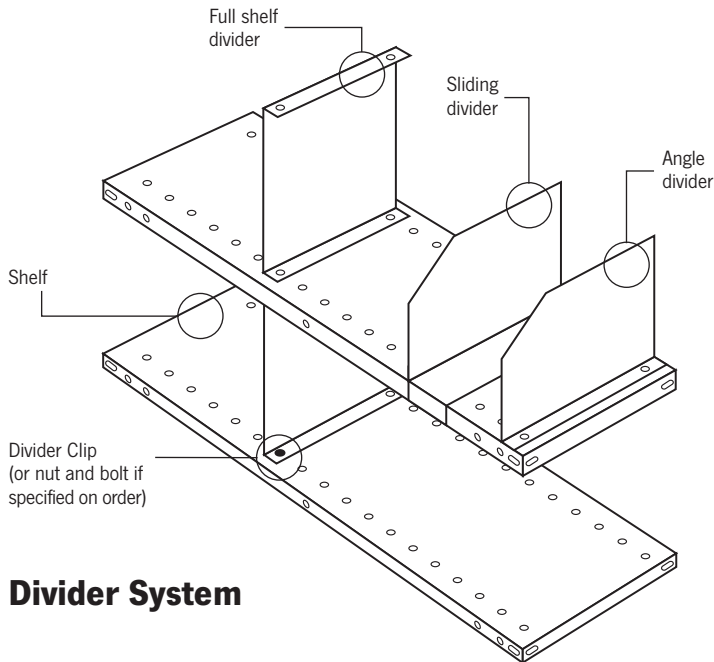

Divider System

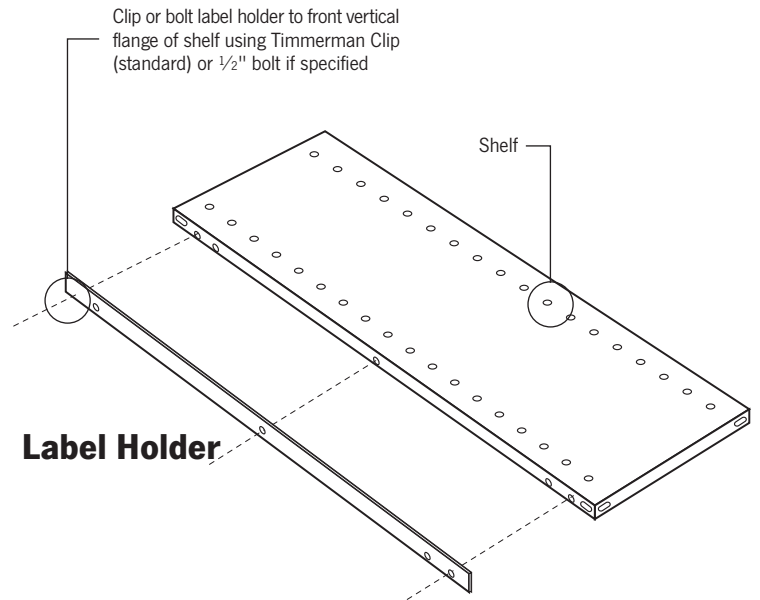

Label Holder

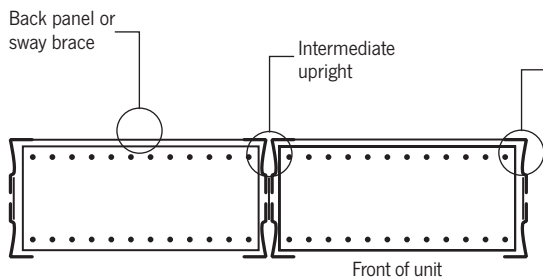

Angle Post Unit

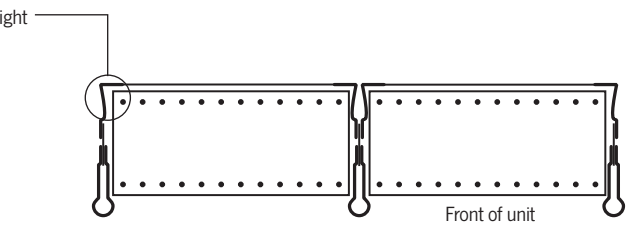

Beaded or Delta Post Unit

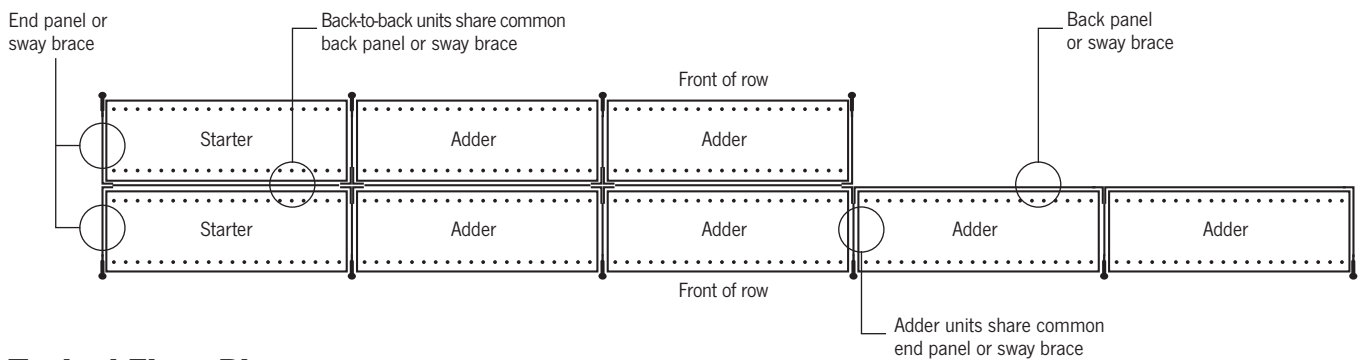

Typical Floor Plan

General Information

Prices

All prices are per unit shipped K.D. (unless otherwise specified) F.O.B. shipping point. Price subject to change without notice. Minimum invoice charge \$100.00 net.

Shipping

Unless a preferred routing is specified on your order, shipments will be made the best way, transportation charges collect.

- Freight class: 70
- F.O.B. points: San Dimas, CA 91773
Plano, TX 75074
Paris, KY 40361

Terms

Net 30 days — subject to credit approval.

Specifications

Sizes and weights shown are approximate (weights are listed in pounds and tenths of a pound).

Finish

Standard finish is gray, and will be furnished unless otherwise specified. Other colors available, subject to delayed delivery and additional cost.

Special Work and Non-Stock Items

Not subject to cancellation or return.
We reserve the right to overship by 5%.

Drawings

Special engineering or drawings for approval can be prepared at additional cost.

Damage in Transit

For your protection, examine each shipment carefully. If there is any evidence of damage or shortage in transit, insist that the delivering Carrier make appropriate notation on the freight bill before you sign it. If concealed damage is discovered after receipt of shipment, immediately notify carrier, requesting inspection report to support your claim. Any claim for damage or shortage in transit must be filed with the delivering carrier. We will not accept return of merchandise damaged in transit. Your recourse is with the delivering carrier.

Returned Merchandise

No goods are to be returned without written factory authorization. A handling charge of 20% will be made for all merchandise returned. Subject to count and inspection.

Product Warranty

The warranty stated herein is in lieu of all other warranties, expressed or implied, including, but not limited to merchantability or fitness for a particular purpose. All products sold by seller are warranted for a period of one year from the date of shipment to the purchaser to be free from defects in materials and workmanship under normal use and service.

Seismic Conditions

Western Pacific Storage Solutions will not be responsible for conformity of building or its fire protection devices to existing codes and regulations due to the installation of our product. In seismic areas, building authority approval and safe design may necessitate a full seismic engineering analysis at additional cost. Seismic analysis is the responsibility of the dealer and/or customer. Western Pacific Storage Solutions will not be liable for safety of design if a seismic analysis is not performed. Please contact our Engineering Department for assistance.

Quotation Form

Shelving Unit

Type

- Open
- Open with Closed Ends
- Closed
- Other _____

Color

- Gray
- Other _____
(upcharge applies)

Footplates

- Standard
- Seismic

Posts

Type

- Angle
- Delta
- Beaded

Height

- 7'1"
- 8'1"
- Other _____

Shelves

Width

- 36"
- 48"
- Other _____

Depth

- 12" 15"
- 18" 24"
- 30" 36"
- Other _____

Gauge

- 18 gauge
- 20 gauge

Reinforcement

- Bar
- Angle
- front and rear
- front only

Number of Shelves (including top and bottom) _____

Load Capacity (uniform weight distribution) _____

Accessories

Closed Base Strips

- 1 1/2" height
- 3" height

Label Holders

Dividers

- Full height
- Sliding
- Angle

Other _____

Notes

Specifications

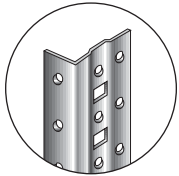

Angle Post

- 14-gauge steel up to 97" length
- 13-gauge steel over 97" length
- Stock sizes are 40", 61", 73", 85", 88", 97", 109", 121", 145" and 181"
- Additional sizes available on production runs (1 1/2" increments plus 1")
- Shelves adjustable on 1 1/2" centers
- Maximum length 21'

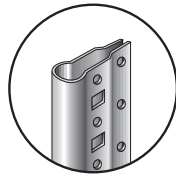

Beaded Post

- 13-gauge cold-rolled steel
- Stock sizes are 40", 61", 73", 85", 88", 97", 109", 121", 145" and 181"
- Shelves adjustable on 1 1/2" centers
- Maximum length 21'

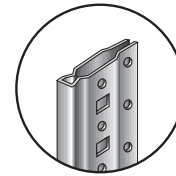

Delta Post

- 14-gauge cold-rolled steel
- Stock sizes are 61", 73", 85", 88", 97", 109" and 121"
- Additional sizes available on production runs (1 1/2" increments plus 1")
- Shelves adjustable on 1 1/2" centers
- Maximum length 10'
- Not suitable for splicing

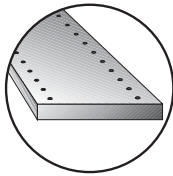

Shelves

- Available in 18-gauge or 20-gauge steel
- 1 1/4" profile
- Triple flanged front and rear
- Double flanged on sides

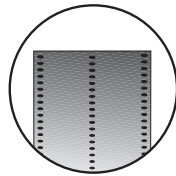

Back and End Panel

- 24-gauge cold rolled steel
- Back panel stock widths are 30", 36", 42" and 48"
- End panel stock widths are 12", 15", 18", 24", 30" and 36"
- Stock heights are 40", 61", 73", 85", 88", 97", 109" and 121"
- Furnished in two pieces or more; overlap 1" min.
- Additional heights available on production runs (1 1/2" increments plus 1")

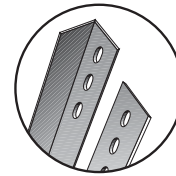

Reinforcing Bar and Angle

- 12-gauge steel
- Bar is 1" wide
- Angle is 1" x 1"
- Available for 30", 36", 42" and 48" widths

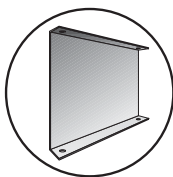

Full Shelf Dividers

- 20-gauge steel
- Depths available are 12", 15", 18" and 24"
- Heights available are 6", 7 1/2", 9", 10 1/2", 12", 13 1/2", 15", 16 1/2", 18" and 24"

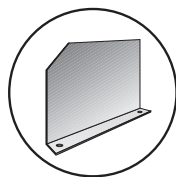

Angle Dividers

- 18- or 20-gauge steel
- Depths available are 12", 15", 18" and 24"
- Heights available are 4", 6" and 9"

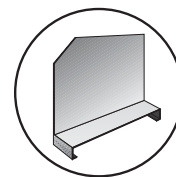

Sliding Dividers

- 20-gauge steel
- Depths available are 12", 15" and 18"
- Heights available are 6" and 9"
- Not for use with Bin Fronts or Closed Base Strips

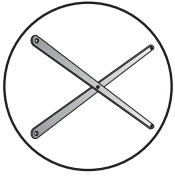

Sway Braces

- 1" wide, 13-gauge steel
- Available for 12", 15", 18", 24", 30", 32", 36", 42" and 48" widths or depths

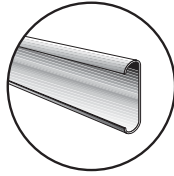

Label Holder

- 24-gauge steel
- 1⁵/₁₆" high to fit a 7/8" label (1" nominal)
- Available for 24", 30", 36", 42" and 48" widths
- Lengths are 2 1/2" under nominal shelf width

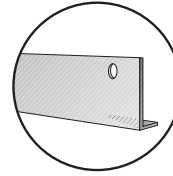

Closed Base Strip

- 18-gauge steel
- Available in 1 1/2" or 3" heights
- 30", 36", 42" and 48" widths available
- Bolts to bottom shelf, enclosing bottom of unit

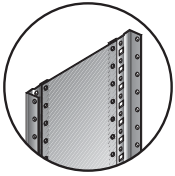

Welded End Upright Assembly (Angle Post)

- 24-gauge end panel spot welded to front and rear posts
- 1/4" spot weld on minimum 18" centers
- 1 Angle Post in front and 1 Angle Post in rear of assembly

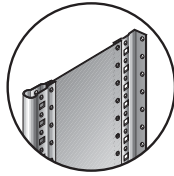

Welded End Upright Assembly (Beaded Post)

- 24-gauge end panel spot welded to front and rear posts
- 1/4" spot weld on minimum 18" centers
- 1 Beaded Post in front and 1 Angle Post in rear of assembly

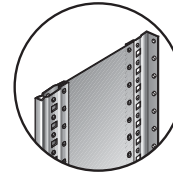

Welded End Upright Assembly (Delta Post)

- 24-gauge end panel spot welded to front and rear posts
- 1/4" spot weld on minimum 18" centers
- 1 Delta Post in front and 1 Angle Post in rear of assembly

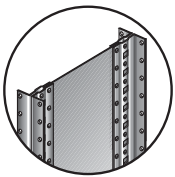

Welded Intermediate Upright Assembly (Angle Post)

- 24-gauge end panel spot welded to front and rear posts
- 1/4" spot weld on minimum 18" centers
- 2 Angle Posts in front and 2 Angle Posts in rear of assembly

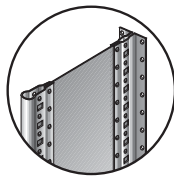

Welded Intermediate Upright Assembly (Beaded Post)

- 24-gauge end panel spot welded to front and rear posts
- 1/4" spot weld on minimum 18" centers
- 1 Beaded Post in front and 2 Angle Posts in rear of assembly

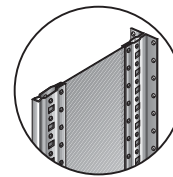

Welded Intermediate Upright Assembly (Delta Post)

- 24-gauge end panel spot welded to front and rear posts
- 1/4" spot weld on minimum 18" centers
- 1 Delta Post in front and 2 Angle Posts in rear of assembly

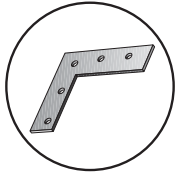

Angle Gusset

- 12-gauge steel
- 5" x 3 3/4" x 3/4"
- For use with Angle Posts only
- Replace cross braces in light duty applications
- Not recommended for seismic applications



Shelf Clips

- 14-gauge steel
- Compression type clips

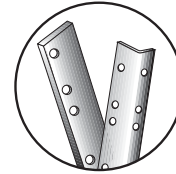

Post Splice

- Angle Post Splice Angle
- 5 1/2" x 1 1/16" x 3/4" angle
 - 13-gauge steel
 - Eight holes for Grade 5 bolts and nuts

Beaded Post Splice Bar

- 5" x 1 1/4" x 1/4"
- Four holes for Grade 5 bolts and nuts

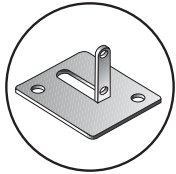

Seismic Footplate

- 10-gauge steel
- 4" x 3 1/2"
- 2 holes in base to accommodate 3/8" diameter anchor
- 2 holes in flange for bolting to post (1/4" diameter, grade 5)

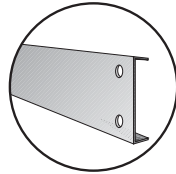

Bin Front

- 18- or 20-gauge steel
- Available in 1 1/2" or 3" heights
- 36", 42" and 48" widths available
- Bin Front Adapters needed for use with Delta or Beaded Posts

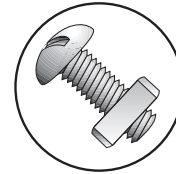

Nuts and Bolts

- 1/4" diameter
- 20 threads per inch
- Material is ASTM A307, Grade 2
- Allowable shear stress 10 ksi based on gross (nominal) are (500 lbs/bolt single shear)
- Allowable tensile stress is 20 ksi based on gross area (1000 lbs/bolt)
- Deck support bolts are Grade 5



Material

- ASTM A569, AISI 1008
- Minimum yield strength 33 ksi



Paint

- Electrostatic powder coat phosphatized baked enamel, oven dried, minimum 1 mil thick
- Standard color: gray
- Non-stock colors: blue, beige, green, black, red (surcharge will apply)
- Custom colors available