



HEAVY-DUTY MODULAR CABINET

The Rousseau modular cabinet has been completely re-engineered in order to better respond to our customers needs. It is distinguished by the vast array of dimensions offered, accessories and its perfect modularity, but most of all by its durability.

The Rousseau cabinet comes in 5 different widths, each offered in 2 depths, for a total of 10 combinations, each available in 6 heights. Add to that the 10 drawer heights, and you have an incredible choice of possibilities. You're guaranteed to find the right size for your specific application.

Tested by an independent laboratory, the Rousseau cabinet proved to be the most durable on the market. The trials proved just how superior our drawer is, as it completed three times as many cycles as its closest competitor (see page 120). This allows us to be 100% confident in offering you a lifetime warranty on the drawer.

The Rousseau cabinet, in addition to being sturdy, offers a refined and unique look, which will stand the test of time. A shining example of unwavering durability.



R5AEE-5803

Heavy-Duty Modular Cabinet

The Rousseau Advantages

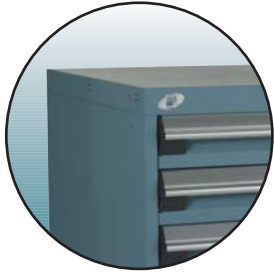

Sturdy and distinct appearance that works in all sorts of different environments.

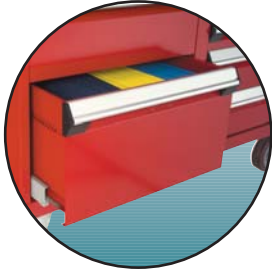

10 drawer heights and 7 drawer side heights are available.



True North American dimensions which allow for perfect modularity.

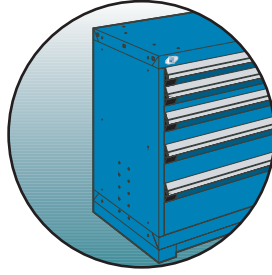

Housings with predetermined fixing zones for installation of accessories : work surfaces, shelves, etc.

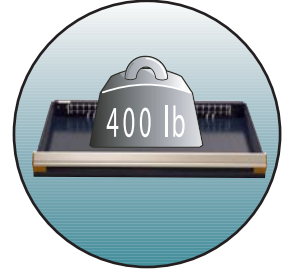

400 lb capacity per drawer. The most heavy-duty in the industry. Lifespan is 3 times longer than its closest rival.

General Dimensions

Available Heights

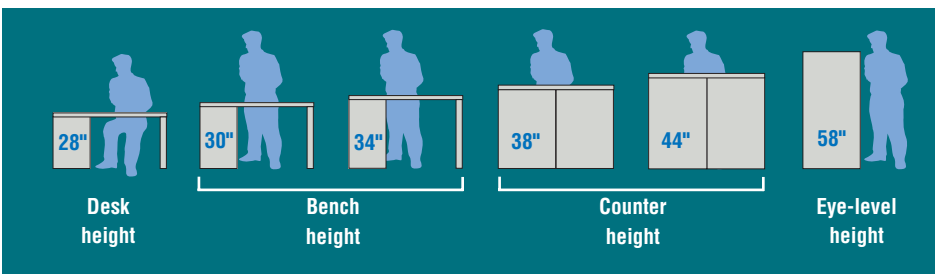

Width x Depth

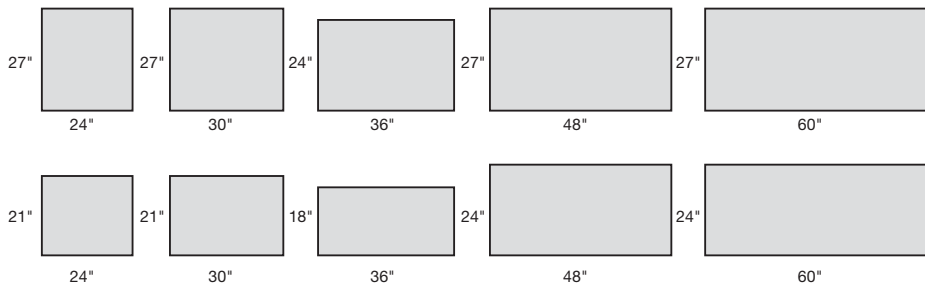

Index	Page(s)
Heavy-Duty Modular Cabinet	4 - 5
Proposals	6 - 9
Accessories	10 - 15
Components	16 - 18
Light-Duty Cabinet	19
Proposals	20 - 21
Accessories	22
Components	23

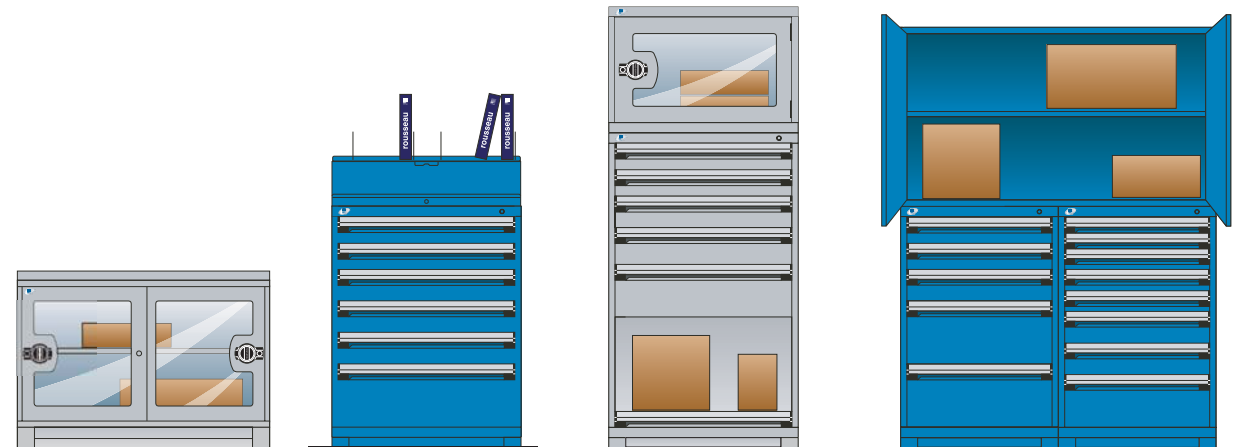

Shown here are several of the more popular heavy-duty modular cabinet models.

All proposals include a 2" front-access forklift base and a lock on the cabinet housing (for models with more than one drawer) or on the door.

Doors are factory installed with hinges on the right side. They may be installed on the left side, upon request.

IMPORTANT Drawer partitions are included in models.

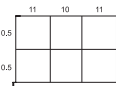

See number of compartments and proposed layouts on the following page.

NOTE
For drawers without partitioning, refer to the price list.
Ex. : R5ACD-2801 with R5ACD-2802 without

 Specify the type of key desired : KA, KD or MK. SEE PAGE 16

24" x 21" and 24" x 27" (W x D)

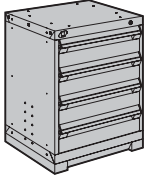

6"
6"
6"
6"

4 drawers
R5ACD-2801 24" x 21" x 30"
R5ACG-2801 24" x 27" x 30"

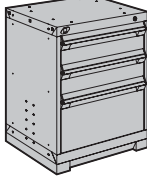

6"
6"
12"

3 drawers
R5ACD-2803 24" x 21" x 30"
R5ACG-2803 24" x 27" x 30"

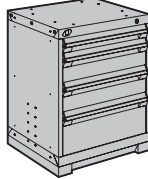

3"
6"
6"
9"

4 drawers
R5ACD-2805 24" x 21" x 30"
R5ACG-2805 24" x 27" x 30"

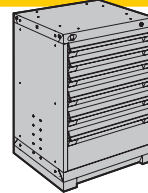

3"
3"
4"
4"
4"
8"

6 drawers
R5ACD-3001 24" x 21" x 32"
R5ACG-3001 24" x 27" x 32"

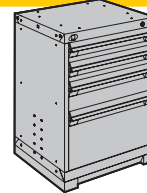

4"
4"
6"
12"

4 drawers
R5ACD-3005 24" x 21" x 32"
R5ACG-3005 24" x 27" x 32"

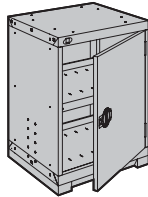

26"

1 door / 1 adjustable shelf /
1 bottom shelf
R5ACD-3009 24" x 21" x 32"
R5ACG-3009 24" x 27" x 32"

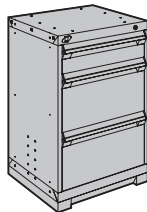

6"
12"
12"

3 drawers
R5ACD-3401 24" x 21" x 36"
R5ACG-3401 24" x 27" x 36"

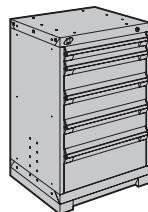

3"
6"
6"
6"
9"

5 drawers
R5ACD-3403 24" x 21" x 36"
R5ACG-3403 24" x 27" x 36"

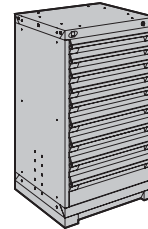

3"
3"
3"
4"
4"
4"
4"
4"
6"

9 drawers
R5ACD-3805 24" x 21" x 40"
R5ACG-3805 24" x 27" x 40"

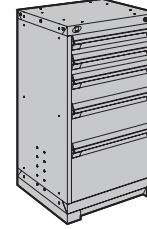

4"
4"
6"
8"
12"

5 drawers
R5ACD-3807 24" x 21" x 40"
R5ACG-3807 24" x 27" x 40"

30" x 21" and 30" x 27" (W x D)

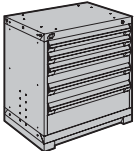

3"
3"
5"
5"
8"

5 drawers
R5ADD-2801 30" x 21" x 30"
R5ADG-2801 30" x 27" x 30"

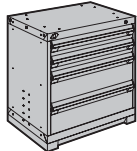

4"
4"
8"
8"

4 drawers
R5ADD-2803 30" x 21" x 30"
R5ADG-2803 30" x 27" x 30"

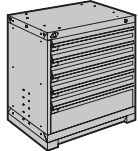

4"
4"
4"
4"
8"

5 drawers
R5ADD-2805 30" x 21" x 30"
R5ADG-2805 30" x 27" x 30"

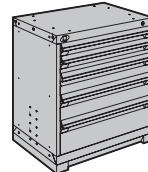

3"
4"
5"
6"
8"

5 drawers
R5ADD-3003 30" x 21" x 32"
R5ADG-3003 30" x 27" x 32"

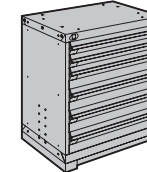

3"
3"
5"
5"
5"
8"

6 drawers
R5ADD-3007 30" x 21" x 32"
R5ADG-3007 30" x 27" x 32"

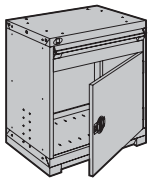

6"
20"

1 drawer / 1 door /
1 bottom shelf
R5ADD-3009 30" x 21" x 32"
R5ADG-3009 30" x 27" x 32"

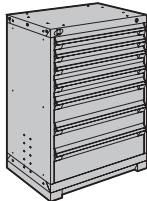

3"
3"
4"
6"
6"
8"

7 drawers
R5ADD-3801 30" x 21" x 40"
R5ADG-3801 30" x 27" x 40"

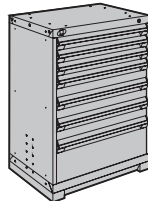

3"
3"
5"
5"
5"
10"

7 drawers
R5ADD-3803 30" x 21" x 40"
R5ADG-3803 30" x 27" x 40"

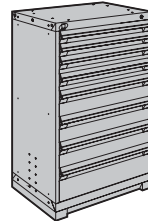

3"
3"
4"
6"
6"
6"
8"

8 drawers
R5ADD-4401 30" x 21" x 46"
R5ADG-4401 30" x 27" x 46"

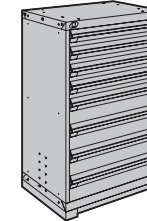

4"
4"
4"
6"
6"
6"
6"

8 drawers
R5ADD-4407 30" x 21" x 46"
R5ADG-4407 30" x 27" x 46"

Proposals

Number of Compartments (layout code)										
Drawer dimensions	24" x 21"	24" x 27"	30" x 21"	30" x 27"	36" x 18"	36" x 24"	48" x 24"	48" x 27"	60" x 24"	60" x 27"
3" to 5"	12 (0308)	20 (0316)	24 (0518)	25 (0420)	24 (0518)	30 (0524)	40 (0732)	32 (0724)	70 (1356)	84 (1370)
6" to 8"	9 (0206)	12 (0209)	12 (0308)	12 (0308)	8 (0304)	12 (0308)	15 (0410)	15 (0410)	24 (0716)	21 (0614)
9" and higher	4 (0102)	6 (0104)	6 (0203)	9 (0206)	6 (0203)	9 (0206)	8 (0304)	8 (0304)	12 (0308)	12 (0308)

NOTE For inside drawer dimensions, see pages 122 -123.

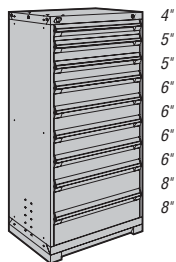

9 drawers
R5ADD-5805 30" x 21" x 60"
R5ADG-5805 30" x 27" x 60"

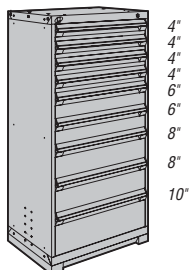

9 drawers
R5ADD-5809 30" x 21" x 60"
R5ADG-5809 30" x 27" x 60"

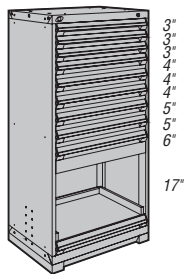

9 drawers / 1 roll-out shelf
R5ADD-5811 30" x 21" x 60"
R5ADG-5811 30" x 27" x 60"

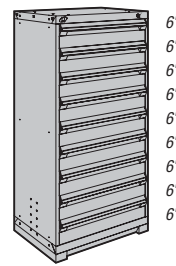

9 drawers
R5ADD-5813 30" x 21" x 60"
R5ADG-5813 30" x 27" x 60"

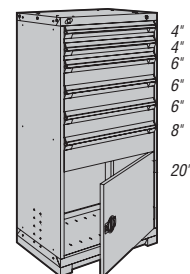

6 drawers / 1 door /
1 bottom shelf
R5ADD-5819 30" x 21" x 60"
R5ADG-5819 30" x 27" x 60"

36" x 18" and 36" x 24" (W x D)

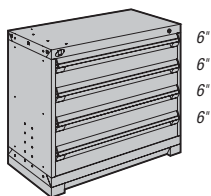

4 drawers
R5AEC-2801 36" x 18" x 30"
R5AEE-2801 36" x 24" x 30"

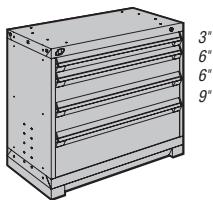

4 drawers
R5AEC-2803 36" x 18" x 40"
R5AEE-2803 36" x 24" x 40"

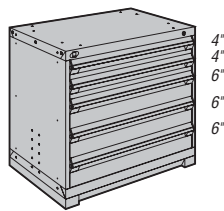

5 drawers
R5AEC-3005 36" x 18" x 32"
R5AEE-3005 36" x 24" x 32"

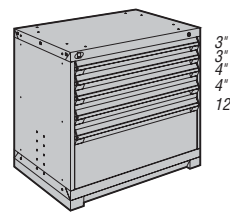

5 drawers
R5AEC-3011 36" x 18" x 32"
R5AEE-3011 36" x 24" x 32"

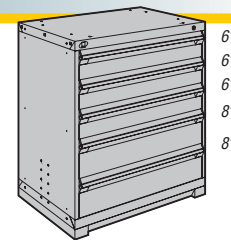

5 drawers
R5AEC-3805 36" x 18" x 40"
R5AEE-3805 36" x 24" x 40"

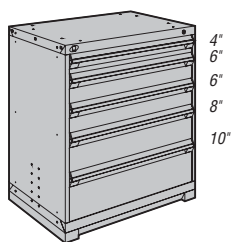

5 drawers
R5AEC-3807 36" x 18" x 40"
R5AEE-3807 36" x 24" x 40"

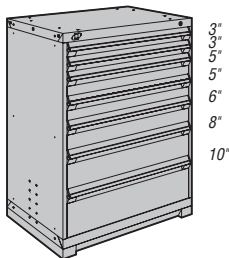

7 drawers
R5AEC-4403 36" x 18" x 46"
R5AEE-4403 36" x 24" x 46"

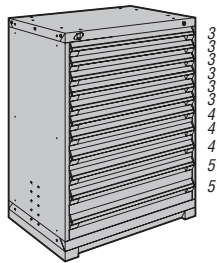

11 drawers
R5AEC-4405 36" x 18" x 46"
R5AEE-4405 36" x 24" x 46"

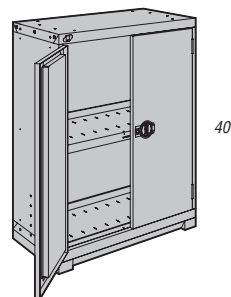

Double door / 1 adjustable shelf /
1 bottom shelf
R5AEC-4412 36" x 18" x 46"
R5AEE-4412 36" x 24" x 46"

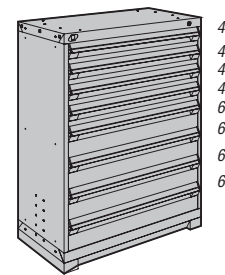

8 drawers
R5AEC-4413 36" x 18" x 46"
R5AEE-4413 36" x 24" x 46"

Proposals

CABINET

60" x 24" and 60" x 27" (W x D)

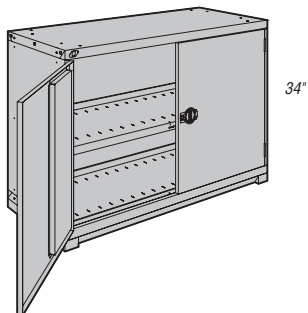

Double door / 1 adjustable shelf / 1 bottom shelf

R5AKE-3802	60" x 24" x 40"
R5AKG-3802	60" x 27" x 40"

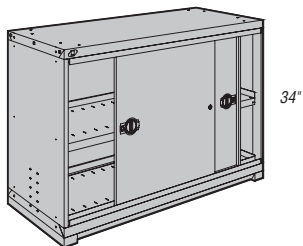

1 sliding door / 1 adjustable shelf / 1 bottom shelf

R5AKE-3804	60" x 24" x 40"
R5AKG-3804	60" x 27" x 40"

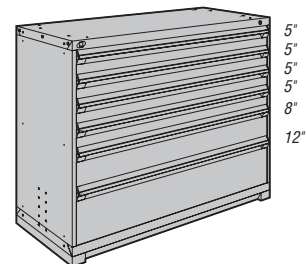

6 drawers

R5AKE-4401	60" x 24" x 46"
R5AKG-4401	60" x 27" x 46"

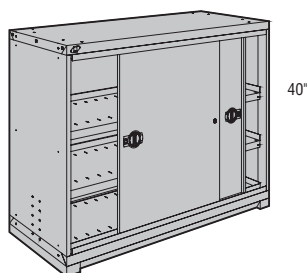

1 sliding door / 2 adjustable shelves / 1 bottom shelf

R5AKE-4406	60" x 24" x 46"
R5AKG-4406	60" x 27" x 46"

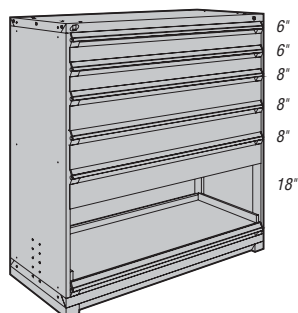

5 drawers / 1 roll-out shelf

R5AKE-5801	60" x 24" x 60"
R5AKG-5801	60" x 27" x 60"

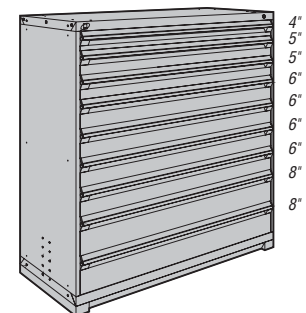

9 drawers

R5AKE-5803	60" x 24" x 60"
R5AKG-5803	60" x 27" x 60"



R5AHG-5815



R5AHG-5817



R5AHG-5819

Security Accessories

Vertical Security Bar

RB10



Locks all of the cabinet drawers with one padlock;
Safety hasp is located at the top of the bar to facilitate access;
Installs on the right side;
Available to cover overall drawer heights from 24" to 54";
Complete access to drawers is possible, even when installed against a wall;
Possible to install more than one bar on the same cabinet (for different users).

Product #	Height
RB10-24A	24"
RB10-26A	26"
RB10-30A	30"
RB10-34A	34"
RB10-40A	40"
RB10-54A	54"

Security Panel

RF91

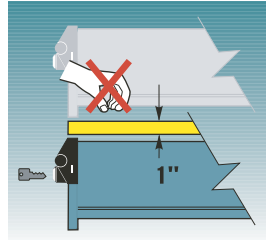

Compatible with vertical security bar and drawer lock;
Blocks access between two drawers with locks;
Usable space in cabinet reduced by 1";
Installed between two drawers;
Allows for the cabinet to be divided up for more than one user.

Product #	W x D
RF91-2421	24" x 21"
RF91-2427	24" x 27"
RF91-3021	30" x 21"
RF91-3027	30" x 27"
RF91-3618	36" x 18"
RF91-3624	36" x 24"
RF91-4824	48" x 24"
RF91-4827	48" x 27"
RF91-6024	60" x 24"
RF91-6027	60" x 27"

True One-Drawer-at-a-Time System

RB15

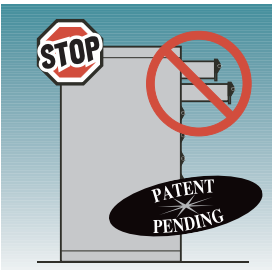

Prevents opening several drawers simultaneously. This ensures cabinet stability and protects the users;

To retrofit this mechanism, order RB15-XX-XX; for factory installation, add A to the cabinet housing number;

SEE PAGE 16

One kit per cabinet.

Product #	Cabinet Height
RB15-28-08	28"
RB15-30-08	30"
RB15-34-10	34"
RB15-38-11	38"
RB15-44-13	44"
RB15-58-18	58"

Cabinet Lock

L3



Allows user to lock all drawers and roll-out shelves in the cabinet at same time;

Possible to change drawer and roll-out shelf positions;

Easy to retrofit;

Order by adding L3 to the cabinet housing number. Ex. : RA30-302758L3.

Product #
L3

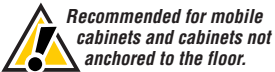

Cabinet Tops

Slope Top

RC30

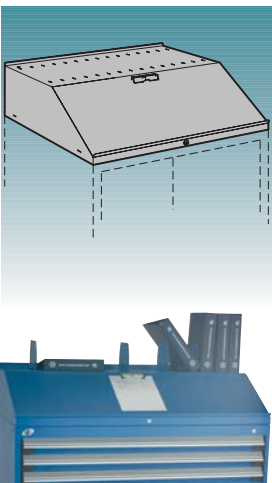

The 30° inclined surface opens to store documents or other items;

Adapted to install a lamp with a 1/2" diameter pivot rod;

Can receive SH52 divider every 2" c/c (except for 18" D);

Capacity : 100 lb (evenly distributed);

For compatibility with doors with frame, choose top that is 3" deeper than your cabinet. Ex. : 27" D cabinet + door with 3" frame = 30" D slope top;

Standard lock included.

Product #	W x D x H	Compatible Divider
RC30-242708L3	24" x 27" x 8"	SH52-1506
RC30-302708L3	30" x 27" x 8"	SH52-1506
RC30-303008L3	30" x 30" x 8"	SH52-1806
RC30-362408L3	36" x 24" x 8"	SH52-1206
RC30-362708L3	36" x 27" x 8"	SH52-1506
RC30-482408L3	48" x 24" x 8"	SH52-1206
RC30-482708L3	48" x 27" x 8"	SH52-1506
RC30-483008L3	48" x 30" x 8"	SH52-1806

Specify type of key : KA, KD or MK. SEE PAGE 16

Partial Divider

SH52

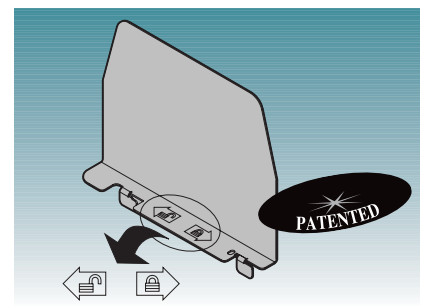

(Pictograms to facilitate installation)

Innovative patented divider, facilitates easy position changes;

Height : 5 1/2";

Easy installation, without tools.

Product #	Divider Depth
SH52-1206	7 1/8"
SH52-1506	10 1/8"
SH52-1806	13 1/8"

Steel Top with Rubber Mat

RC32



Non-slip rubber surface;
Compatible with double cabinets;
Sides and back formed with a double fold, 1" high.

Product #	W x D
RC32-2421-01	24" x 21"
RC32-2427-01	24" x 27"
RC32-3021-01	30" x 21"
RC32-3024-01	30" x 24"
RC32-3027-01	30" x 27"
RC32-3030-01	30" x 30"
RC32-3618-01	36" x 18"
RC32-3621-01	36" x 21"
RC32-3624-01	36" x 24"
RC32-3627-01	36" x 27"

Product #	W x D
RC32-4224-01	42" x 24"
RC32-4227-01	42" x 27"
RC32-4824-01	48" x 24"
RC32-4827-01	48" x 27"
RC32-4830-01	48" x 30"
RC32-6024-01	60" x 24"
RC32-6027-01	60" x 27"
RC32-6030-01	60" x 30"
RC32-7224-01	72" x 24"
RC32-7227-01	72" x 27"
RC32-7230-01	72" x 30"

Stainless Steel Top

RC35



Serves as a work surface and protects cabinet against impacts;

Composite wood top with stainless steel cover (brushed finish #4);

Welded corner for attractive look;

Thickness : 1 3/4";

Compatible with double cabinets;

Note : Other dimensions available, contact your customer representative.

Product #	W x D
RC35-3027	30" x 27"
RC35-3624	36" x 24"
RC35-4824	48" x 24"
RC35-4827	48" x 27"

Product #	W x D
RC35-6024	60" x 24"
RC35-6027	60" x 27"
RC35-6030	60" x 30"
RC35-7224	72" x 24"
RC35-7230	72" x 30"

Painted Steel Top

RC37



Serves as a work surface and protects cabinet against impacts;

Composite wood top with painted steel cover;

Welded corners for attractive look;

Thickness : 1 3/4";

Compatible with double cabinets.

Product #	W x D
RC37-3027	30" x 27"
RC37-3030	30" x 30"
RC37-3624	36" x 24"
RC37-3627	36" x 27"
RC37-4224	42" x 24"
RC37-4227	42" x 27"
RC37-4824	48" x 24"
RC37-4827	48" x 27"
RC37-4830	48" x 30"

Product #	W x D
RC37-6024	60" x 24"
RC37-6027	60" x 27"
RC37-6030	60" x 30"
RC37-7224	72" x 24"
RC37-7227	72" x 27"
RC37-7230	72" x 30"

Laminated Wood Top

WS14



Made of laminated hardwood strips;

Rounded 90° edge at the front for added comfort;

Thickness : 1 3/4";

Compatible with double cabinets;

Attractive look.

Product #	W x D
WS14-3027A	30" x 27"
WS14-3030A	30" x 30"
WS14-3624A	36" x 24"
WS14-3627A	36" x 27"
WS14-4224A	42" x 24"
WS14-4227A	42" x 27"
WS14-4824A	48" x 24"
WS14-4827A	48" x 27"
WS14-4830A	48" x 30"

Product #	W x D
WS14-6024A	60" x 24"
WS14-6027A	60" x 27"
WS14-6030A	60" x 30"
WS14-7224A	72" x 24"
WS14-7227A	72" x 27"
WS14-7230A	72" x 30"

Galvanized Steel Top

RC36



Serves as a work surface and protects cabinet against impacts;

Composite wood top with galvanized steel cover;

Thickness : 1 3/4";

Compatible with double cabinets.

Product #	W x D
RC36-3027	30" x 27"
RC36-3030	30" x 30"
RC36-3624	36" x 24"
RC36-3627	36" x 27"
RC36-4224	42" x 24"
RC36-4227	42" x 27"
RC36-4824	48" x 24"
RC36-4827	48" x 27"
RC36-4830	48" x 30"

Product #	W x D
RC36-6024	60" x 24"
RC36-6027	60" x 27"
RC36-6030	60" x 30"
RC36-7224	72" x 24"
RC36-7227	72" x 27"
RC36-7230	72" x 30"

Back and Side Stop

RC37

WS18



Serves as a work surface and protects cabinet against impacts;

Composite wood top with painted steel cover;

Welded corners for attractive look;

Thickness : 1 3/4";

Compatible with double cabinets.

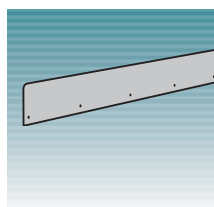

Painted steel;

Can be installed on back or sides according to top dimensions;

Can be installed on WS14, RC35, RC36 and RC37 tops;

Height : 5". Clears top by approx. 3 1/4".

Product #	Length
WS18-2405	24"
WS18-2705	27"
WS18-3005	30"
WS18-3605	36"
WS18-4205	42"
WS18-4805	48"
WS18-6005	60"
WS18-7205	72"

NOTE

For compatibility with doors with frame, choose top that is 3" deeper than your cabinet.
Ex. : 27"D cabinet + door with 3" frame = 30" D top.

ESD Protection

ESD Cabinet

RC50



Allows for the safe storage of electronic components; Dissipative paint respects ESD Association standards. Point to point and point to ground resistance is between $1 \times 10^6 \Omega$ and $1 \times 10^9 \Omega$; Grounding cord and ground wrist strap socket are included. Cord resistance is $1 M \Omega$;

To order a cabinet equipped with protection against electrostatic discharges, indicate RC50-01. Dissipative paint is Black 090.

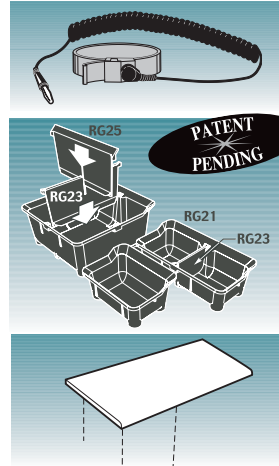

GROUNDING WRIST STRAP

Made of stretch material; Comes with a 6" cord with $1M \Omega$ resistance; Dissipates electric charges that may damage electronic components.

Product #
70000320

CONDUCTIVE PLASTIC BINS

SEE PAGE 140

DISSIPATIVE TOP

SEE PAGE 88

Stacking Cabinets / Sink Cabinets

30" and 36" Wide Stacking Cabinets

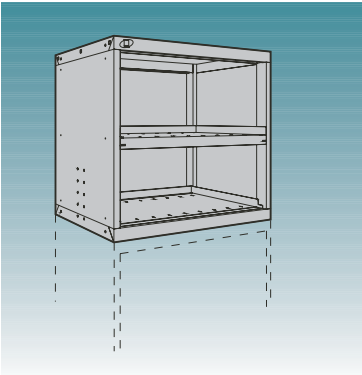

1 shelf, adjustable every 1" c/c;
1 bottom shelf;
Standard lock included on doors;
Choice of doors. Complete the product # by referring to chart below.

Product #	W x D x H
R5HDG-24	30" x 27" x 24"
R5HDG-30	30" x 27" x 30"
R5HEC-24	36" x 18" x 24"
R5HEC-30	36" x 18" x 30"
R5HEE-24	36" x 24" x 24"
R5HEE-30	36" x 24" x 30"

Ex. : R5HEE-2403 for a 36"W x 24"D x 24"H cabinet with double integrated doors

00	For cabinet without door
01	For cabinet with single integrated door
02	For cabinet with single integrated glass door
03	For cabinet with double integrated doors
04	For cabinet with double integrated glass doors
05	For cabinet with double doors with frame
06	For cabinet with double glass doors with frame

48" and 60" Wide Stacking Cabinets

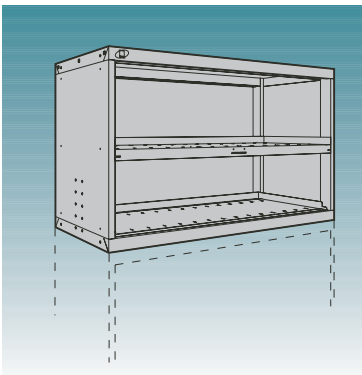

1 shelf, adjustable every 1" c/c;
1 bottom shelf;
Standard lock included on doors;
Choice of doors. Complete the product # by referring to chart below.

Product #	W x D x H
R5HHE-24	48" x 24" x 24"
R5HHE-30	48" x 24" x 30"
R5HHG-24	48" x 27" x 24"
R5HHG-30	48" x 27" x 30"
R5HKE-24	60" x 24" x 24"
R5HKE-30	60" x 24" x 30"
R5HKG-24	60" x 27" x 24"
R5HKG-30	60" x 27" x 30"

Ex. : R5HKE-2407 for a 60"W x 24"D x 24"H cabinet with integrated sliding doors

00	For cabinet without door
03	For cabinet with double integrated doors
04	For cabinet with double integrated glass doors
05	For cabinet with double doors with frame
06	For cabinet with double glass doors with frame
07	For cabinet with integrated sliding doors
08	For cabinet with integrated sliding glass doors
09	For cabinet with sliding doors with frame
10	For cabinet with sliding glass doors with frame



R5XHE-1002

Stacking Cabinet Housing

RA30

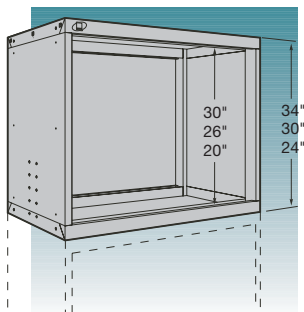

Stacking cabinet housings are designed specifically for stacking on RA30 standard housing units;

Drawers, roll-out shelves, adjustable shelves and bottom shelves can all be installed in these housings;

Compatible with both integrated doors and doors with frame;

Housing heights available : 24", 30" and 34";

To order, complete the part # with height wanted. Ex. : RA30-242130;

Note : Bottom shelf must be ordered separately.

Product #	W x D
RA30-2421	24" x 21"
RA30-2427	24" x 27"
RA30-3021	30" x 21"
RA30-3027	30" x 27"

Product #	W x D
RA30-3618	36" x 18"
RA30-3624	36" x 24"
RA30-4824	48" x 24"
RA30-4827	48" x 27"
RA30-6024	60" x 24"
RA30-6027	60" x 27"

Sink Cabinet

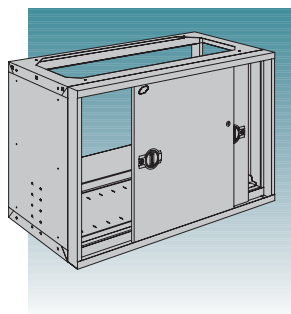

The top has an opening to allow for installation of a sink;

Has an opening on the back of the housing to allow for installation of a drain and pipes;

1 bottom shelf;

Models that have a door with frame are compatible with drawers and roll-out shelves;

Standard lock included;

Compatible with bases;

Heights available : 28", 30" and 34";

To order, complete the part # with height wanted and by referring to chart below for door types.

Ex. : R5TDD-2801;

Note : Work surfaces must be ordered separately (cut-outs are not provided by Rousseau).

SEE PAGE 17

SEE PAGE 88

Product #	W x D
R5TDD-___*	30" x 21"
R5TDG-___*	30" x 27"
R5THD-___	48" x 21"
R5THG-___	48" x 27"

01	For cabinet with single integrated door
02	For cabinet with double integrated doors
03	For cabinet with double doors with frame
04	For cabinet with integrated sliding doors
05	For cabinet with sliding doors with frame

*Models are not compatible with sliding doors.

Adjustable Shelf

RB22 / RB24

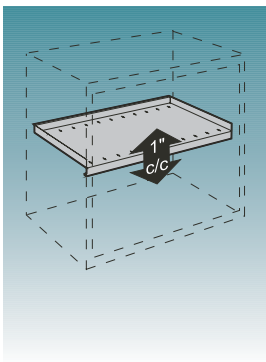

For storing bulky items;

Has edge along the sides and back to prevent items from falling into the bottom of the cabinet;

Adjustable at every 1" c/c;

Up to 400 lb capacity of evenly distributed load;

SH52 dividers can be installed.

Product #	W x D	Capacity*
RB22-2421	24" x 21"	200
RB22-2427	24" x 27"	200
RB24-3021	30" x 21"	400
RB24-3027	30" x 27"	400
RB24-3618	36" x 18"	400
RB24-3624	36" x 24"	400
RB24-4821	48" x 21"	400
RB24-4824	48" x 24"	400
RB24-4827	48" x 27"	400
RB24-6024	60" x 24"	400
RB24-6027	60" x 27"	400

*in pounds

Bottom Shelf

RB23 / RB25

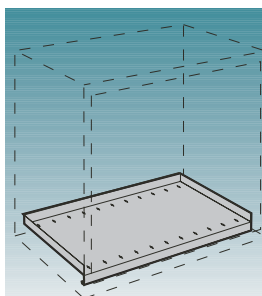

For storing bulky items;

Has edge along the sides and back to prevent items from falling into the bottom of the cabinet;

Up to 400 lb capacity of evenly distributed load;

SH52 dividers can be installed.

Product #	W x D	Capacity*
RB23-2421	24" x 21"	200
RB23-2427	24" x 27"	200
RB25-3021	30" x 21"	400
RB25-3027	30" x 27"	400
RB25-3618	36" x 18"	400
RB25-3624	36" x 24"	400
RB25-4821	48" x 21"	400
RB25-4824	48" x 24"	400
RB25-4827	48" x 27"	400
RB25-6024	60" x 24"	400
RB25-6027	60" x 27"	400

* in pounds

Note : For compatibility with double integrated doors, order an adjustable shelf.

Partial Divider

SH52

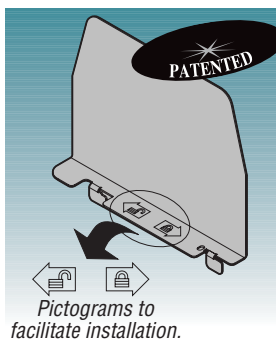

Innovative patented divider, facilitates easy position changes;

Height : 5 1/2";

Easy installation, without tools.

Product #	Divider Depth	For Shelves
SH52-1506	10 1/8"	18" D
SH52-1806	13 1/8"	21" D
SH52-2106	16 1/8"	24" D
SH52-2406	19 1/8"	27" D



R5XTG-3002

Doors

Single Integrated Door, Solid or Glass **RB30 / RB31**

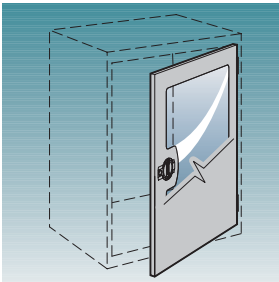

Integrated door : RB30;
 Glass integrated door : RB31;
 Single door for 24", 30" and 36" wide cabinets;
 Compatible with RB23/RB25 bottom shelf and RB22/RB24 adjustable shelf;
 Opens 180° for full access to items stored inside;
 Factory installed on RA30 cabinet housings;
 Standard lock included;
 Some door heights may be combined with drawers mounted above or below. In the latter case, you must order a RB22/RB24 adjustable shelf for installation above the section of drawers;
 Glass door made of impact resistant polycarbonate;
 Order by specifying the choice of door.
 Ex. : RB31-3034L3 for a 30"W x 34"H single integrated glass door.



Product #	W x H
RB_-2420L3	24" x 20"
RB_-2424L3	24" x 24"
RB_-2426L3	24" x 26"
RB_-2430L3	24" x 30"
RB_-2434L3	24" x 34"
RB_-3020L3	30" x 20"
RB_-3024L3	30" x 24"
RB_-3026L3	30" x 26"
RB_-3030L3	30" x 30"

Product #	W x H
RB_-3034L3	30" x 34"
RB_-3040L3	30" x 40"
RB_-3054L3	30" x 54"
RB_-3620L3	36" x 20"
RB_-3624L3	36" x 24"
RB_-3626L3	36" x 26"
RB_-3630L3	36" x 30"
RB_-3634L3	36" x 34"
RB_-3640L3	36" x 40"
RB_-3654L3	36" x 54"



Specify the type of key desired : KA, KD, or MK.
 When unspecified, a KD lock is supplied

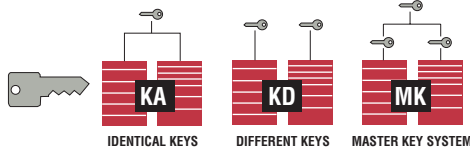

Double Integrated Doors, Solid or Glass **RB35 / RB36**

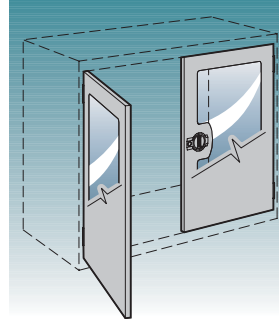

Integrated doors : RB35;
 Glass integrated doors : RB36;
 Double doors for 30", 36", 48" and 60" wide cabinets;
 Compatible with RB24 adjustable shelf;
 Open 180° for full access to items stored inside;
 Factory installed on RA30 cabinet housings;
 Standard lock included;
 Some door heights may be combined with drawers mounted above or below. In the latter case, you must order a RB24 adjustable shelf for installation above the section of drawers or a crossbar for drawers mounted above;



Glass doors made of impact resistant polycarbonate;
 Order by specifying the choice of door.
 Ex. : RB36-4820L3 for 48"W x 20"H double integrated glass doors;
 Note : Not compatible with RB25 bottom shelf.

Product #	W x H
RB_-3020L3	30" x 20"
RB_-3024L3	30" x 24"
RB_-3026L3	30" x 26"
RB_-3030L3	30" x 30"
RB_-3034L3	30" x 34"
RB_-3040L3	30" x 40"
RB_-3054L3	30" x 54"
RB_-3620L3	36" x 20"
RB_-3624L3	36" x 24"
RB_-3626L3	36" x 26"
RB_-3630L3	36" x 30"
RB_-3634L3	36" x 34"
RB_-3640L3	36" x 40"
RB_-3654L3	36" x 54"

Product #	W x H
RB_-4820L3	48" x 20"
RB_-4824L3	48" x 24"
RB_-4826L3	48" x 26"
RB_-4830L3	48" x 30"
RB_-4834L3	48" x 34"
RB_-4840L3	48" x 40"
RB_-4854L3	48" x 54"
RB_-6020L3	60" x 20"
RB_-6024L3	60" x 24"
RB_-6026L3	60" x 26"
RB_-6030L3	60" x 30"
RB_-6034L3	60" x 34"
RB_-6040L3	60" x 40"
RB_-6054L3	60" x 54"

Crossbar for Double Integrated Doors **RB70**

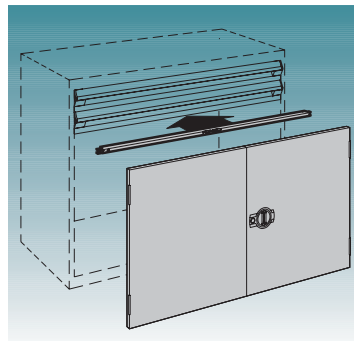

Required for double integrated doors with drawer above.

Product #	Width
RB70-30	30"
RB70-36	36"
RB70-48	48"
RB70-60	60"

Double Doors with Frame, Solid or Glass RB45 / RB46

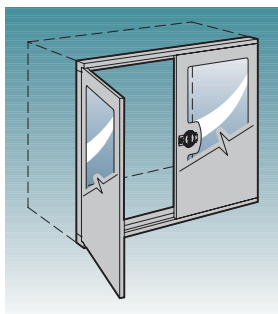

Doors with frame : RB45;
 Glass doors with frame : RB46;
 Double doors for 30", 36", 48" and 60" wide cabinets;
 Can be installed on cabinets with drawers or roll-out shelves;
 Open 180° for full access to items stored inside;
 Factory installed on RA30 cabinet housings;
 Standard lock included;
 Frame thickness : 3";
 Glass door made of impact resistant polycarbonate;
 Order by specifying the choice of door.
 Ex. : RB46-4824L3 for 48"W x 24"H double glass doors with frame.



Product #	W x H
RB -3024L3	30" x 24"
RB -3028L3	30" x 28"
RB -3030L3	30" x 30"
RB -3034L3	30" x 34"
RB -3038L3	30" x 38"
RB -3044L3	30" x 44"
RB -3058L3	30" x 58"
RB -3624L3	36" x 24"
RB -3628L3	36" x 28"
RB -3630L3	36" x 30"
RB -3634L3	36" x 34"
RB -3638L3	36" x 38"
RB -3644L3	36" x 44"
RB -3658L3	36" x 58"

Product #	W x H
RB -4824L3	48" x 24"
RB -4828L3	48" x 28"
RB -4830L3	48" x 30"
RB -4834L3	48" x 34"
RB -4838L3	48" x 38"
RB -4844L3	48" x 44"
RB -4858L3	48" x 58"
RB -6024L3	60" x 24"
RB -6028L3	60" x 28"
RB -6030L3	60" x 30"
RB -6034L3	60" x 34"
RB -6038L3	60" x 38"
RB -6044L3	60" x 44"
RB -6058L3	60" x 58"

Integrated Sliding Doors, Solid or Glass RB50 / RB51

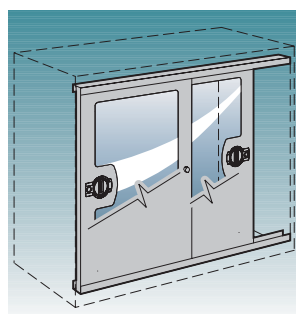

Sliding doors : RB50;
 Glass sliding doors : RB51;
 Doors for 48" and 60" wide cabinets;
 Compatible with RB24 adjustable shelf;
 Maximum opening for access to items stored inside;
 Factory installed on RA30 housings;
 Standard lock included;
 Glass door made of impact resistant polycarbonate;
 Order by specifying the choice of door.
 Ex. : RB51-6020L3 for 60"W x 20"H integrated sliding glass doors;
 Not compatible with RB25 bottom shelf.



Product #	W x H
RB -4820L3	48" x 20"
RB -4824L3	48" x 24"
RB -4826L3	48" x 26"
RB -4830L3	48" x 30"
RB -4834L3	48" x 34"
RB -4840L3	48" x 40"
RB -4854L3	48" x 54"

Product #	W x H
RB -6020L3	60" x 20"
RB -6024L3	60" x 24"
RB -6026L3	60" x 26"
RB -6030L3	60" x 30"
RB -6034L3	60" x 34"
RB -6040L3	60" x 40"
RB -6054L3	60" x 54"

Sliding Doors with Frame, Solid or Glass RB55 / RB56

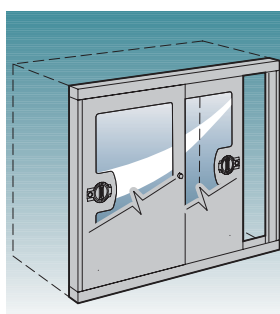

Sliding doors with frame : RB55;
 Glass sliding doors with frame : RB56;
 Sliding doors for 48" and 60" wide cabinets or double cabinets (2 x 24" or 2 x 30");
 Maximum opening for access to items stored inside;
 Can be installed on cabinets with drawers and roll-out shelves;
 Factory installed on RA30 cabinet housings;
 Standard lock included;
 Frame thickness : 3";
 Glass door made of impact resistant polycarbonate;
 Order by specifying the choice of door.
 Ex. : RB56-6024L3 for 60"W x 24"H sliding glass door with frame.



Product #	W x H
RB -4824L3	48" x 24"
RB -4828L3	48" x 28"
RB -4830L3	48" x 30"
RB -4834L3	48" x 34"
RB -4838L3	48" x 38"
RB -4844L3	48" x 44"
RB -4858L3	48" x 58"

Product #	W x H
RB -6024L3	60" x 24"
RB -6028L3	60" x 28"
RB -6030L3	60" x 30"
RB -6034L3	60" x 34"
RB -6038L3	60" x 38"
RB -6044L3	60" x 44"
RB -6058L3	60" x 58"



R5XKG-1001

Housings

Heavy-Duty Cabinet Housing

RA30

Choose from a wide range of housing unit sizes to customize your storage or work space areas.

Modular drawers, roll-out shelves, adjustable and bottom shelves can be installed;

Compatible with integrated doors and doors with frame;

Housing units are equipped with knock-outs :

- on the top to stack cabinets and install accessories or work surfaces
- on the sides and back to anchor cabinets side-by-side and back-to-back as well as for attaching accessories

Includes anchoring kit for concrete floor, for both cabinet housings and bases, and hardware for stacking;

To order cabinet lock, complete product number with L3;

To order a true one-drawer-at-a-time mechanism, complete the product number with A.

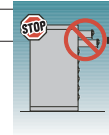

R5AEE-5803

24" and 30" Wide

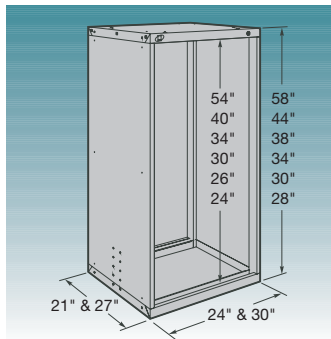

36" Wide

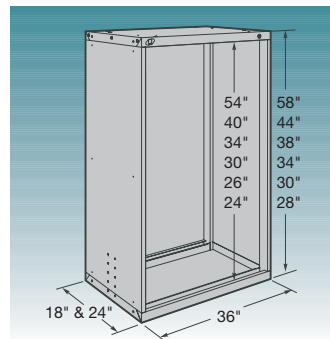

48" and 60" Wide

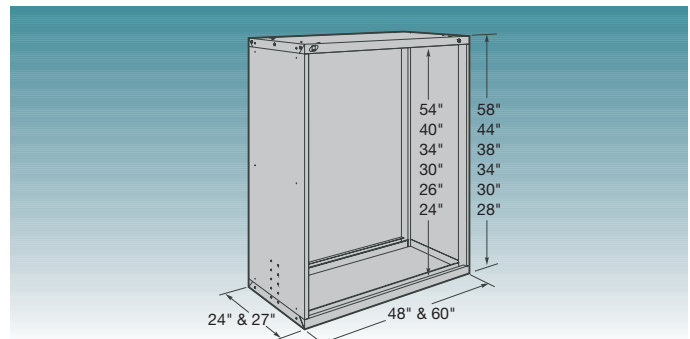

Product #	Total Height	Inside Height
24" x 21"		
RA30-242128	28"	24"
RA30-242130	30"	26"
RA30-242134	34"	30"
RA30-242138	38"	34"
24" x 27"		
RA30-242728	28"	24"
RA30-242730	30"	26"
RA30-242734	34"	30"
RA30-242738	38"	34"
30" x 21"		
RA30-302128	28"	24"
RA30-302130	30"	26"
RA30-302134	34"	30"
RA30-302138	38"	34"
RA30-302144	44"	40"
RA30-302158	58"	54"
30" x 27"		
RA30-302728	28"	24"
RA30-302730	30"	26"
RA30-302734	34"	30"
RA30-302738	38"	34"
RA30-302744	44"	40"
RA30-302758	58"	54"

Product #	Total Height	Inside Height
36" x 18"		
RA30-361828	28"	24"
RA30-361830	30"	26"
RA30-361834	34"	30"
RA30-361838	38"	34"
RA30-361844	44"	40"
RA30-361858	58"	54"
36" x 24"		
RA30-362428	28"	24"
RA30-362430	30"	26"
RA30-362434	34"	30"
RA30-362438	38"	34"
RA30-362444	44"	40"
RA30-362458	58"	54"

Product #	Total Height	Inside Height
48" x 24"		
RA30-482428	28"	24"
RA30-482430	30"	26"
RA30-482434	34"	30"
RA30-482438	38"	34"
RA30-482444	44"	40"
RA30-482458	58"	54"
48" x 27"		
RA30-482728	28"	24"
RA30-482730	30"	26"
RA30-482734	34"	30"
RA30-482738	38"	34"
RA30-482744	44"	40"
RA30-482758	58"	54"

Product #	Total Height	Inside Height
60" x 24"		
RA30-602428	28"	24"
RA30-602430	30"	26"
RA30-602434	34"	30"
RA30-602438	38"	34"
RA30-602444	44"	40"
RA30-602458	58"	54"
60" x 27"		
RA30-602728	28"	24"
RA30-602730	30"	26"
RA30-602734	34"	30"
RA30-602738	38"	34"
RA30-602744	44"	40"
RA30-602758	58"	54"

Cabinet Lock

Allows user to lock all drawers and roll-out shelves in the cabinet at the same time.

Complete product number with L3.

Specify the type of key desired : KA, KD, or MK.
When unspecified, a KD lock is supplied

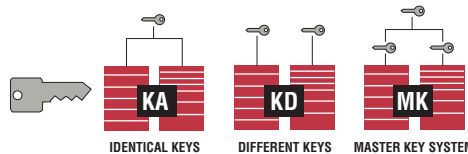

R5AHE-5801

Components

Bases

Front Access Forklift Base

RA52

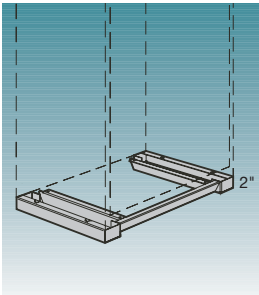

2" high base designed for moving the cabinet from the front with a forklift;

Front cover plate included;

Includes a recessed kick-plate in the center of the cabinet to allow user to stand closer to cabinet;

Designed to enable user to anchor cabinet to the floor;

Compatible with RA74 leveling glides;

Compatible with the RA54 rear base cover plate, offered as an option;

Note : Not compatible with casters;

Note : Not designed for stacking applications.

Product #	W x D
RA52-242102	24" x 21"
RA52-242702	24" x 27"
RA52-302102	30" x 21"
RA52-302702	30" x 27"
RA52-361802	36" x 18"
RA52-362402	36" x 24"

Product #	W x D
RA52-482402	48" x 24"
RA52-482702	48" x 27"
RA52-602402	60" x 24"
RA52-602702	60" x 27"

Front and Side Access Forklift Base

RA53

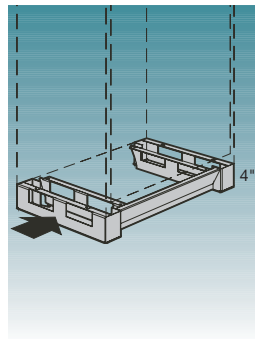

4" high base designed for moving the cabinet from the front or side with a forklift, or from the front with a pallet-jack;

Front cover plate included;

Includes a recessed kick-plate in the center of the cabinet to allow user to stand closer to cabinet;

Designed to enable user to anchor cabinet to the floor;

Compatible with RA74 leveling glides;

Compatible with the RA54 rear base cover plate, offered as an option;

Note : Not compatible with casters;

Note : Not designed for stacking applications.

Product #	W x D
RA53-242104	24" x 21"
RA53-242704	24" x 27"
RA53-302104	30" x 21"
RA53-302704	30" x 27"
RA53-361804	36" x 18"
RA53-362404	36" x 24"

Product #	W x D
RA53-482404	48" x 24"
RA53-482704	48" x 27"
RA53-602404	60" x 24"
RA53-602704	60" x 27"

Angled Cover Plate

RA54

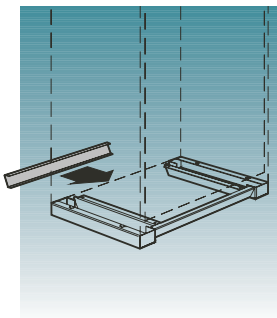

Closes off the back of 2" and 4" forklift bases.

Product #	W x H
RA54-2402	24" x 2"
RA54-2404	24" x 4"
RA54-3002	30" x 2"
RA54-3004	30" x 4"
RA54-3602	36" x 2"
RA54-3604	36" x 4"
RA54-4802	48" x 2"
RA54-4804	48" x 4"
RA54-6002	60" x 2"
RA54-6004	60" x 4"

Leveling Glide Kit

RA74

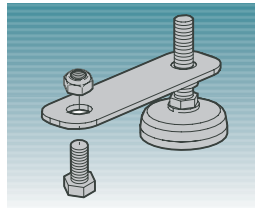

Sold in kits of 4;

Serves to adjust the height of cabinet housings on uneven floor surfaces.

Product #
RA74-01

Recessed Base

RA55

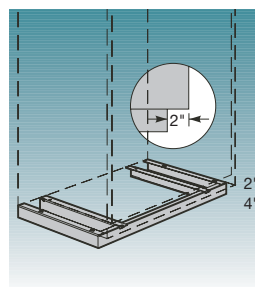

Designed to raise the height of a cabinet by 2" or 4";

Includes a removable cover plate at the front for aesthetics;

Front cover plate is on a straight angle to facilitate cleaning floors;

2" recessed space to allow user to stand closer to cabinet;

Designed to allow user to anchor the cabinet to the floor;

Compatible with the RA56 rear base cover plate, offered as an option;

Note : Not compatible with leveling glides or casters;

Note : Not designed for stacking applications.

Product #	W x D x H
RA55-242102	24" x 21" x 2"
RA55-242104	24" x 21" x 4"
RA55-242702	24" x 27" x 2"
RA55-242704	24" x 27" x 4"
RA55-302102	30" x 21" x 2"
RA55-302104	30" x 21" x 4"
RA55-302702	30" x 27" x 2"
RA55-302704	30" x 27" x 4"
RA55-361802	36" x 18" x 2"
RA55-361804	36" x 18" x 4"

Product #	W x D x H
RA55-362402	36" x 24" x 2"
RA55-362404	36" x 24" x 4"
RA55-482402	48" x 24" x 2"
RA55-482404	48" x 24" x 4"
RA55-482702	48" x 27" x 2"
RA55-482704	48" x 27" x 4"
RA55-602402	60" x 24" x 2"
RA55-602404	60" x 24" x 4"
RA55-602702	60" x 27" x 2"
RA55-602704	60" x 27" x 4"

Straight Cover Plate

RA56

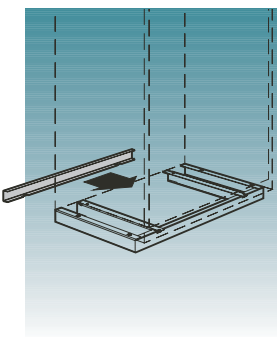

Closes off the back of 2" and 4" recessed bases.

Product #	W x H
RA56-2402	24" x 2"
RA56-2404	24" x 4"
RA56-3002	30" x 2"
RA56-3004	30" x 4"
RA56-3602	36" x 2"
RA56-3604	36" x 4"
RA56-4802	48" x 2"
RA56-4804	48" x 4"
RA56-6002	60" x 2"
RA56-6004	60" x 4"

Drawers and Locking and Security Mechanisms

CABINET

Heavy-Duty Modular Drawer for Cabinet

RF31

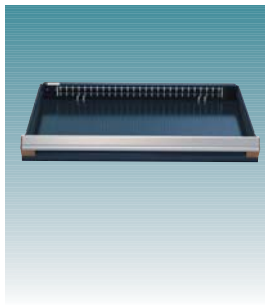

400 lb capacity, 100% extension;

Heavy-duty construction;

Easy to install;

Vast choice of accessories offered to adapt to your storage needs;

Available drawer heights : 3", 4", 5", 6", 7", 8", 9", 10", 12" and 14";

Order by adding the drawer height to the part #.
Ex. : RF31-362406;

For modular drawers with layouts,

SEE PAGES 137-141

SEE PAGES 125-136

Product #	W x D
RF31-2421	24" x 21"
RF31-2427	24" x 27"
RF31-3021	30" x 21"
RF31-3027	30" x 27"
RF31-3618	36" x 18"
RF31-3624	36" x 24"
RF31-4824	48" x 24"
RF31-4827	48" x 27"
RF31-6024	60" x 24"
RF31-6027	60" x 27"

Heavy-Duty 3-Sided Access Roll-Out Shelf

RF44

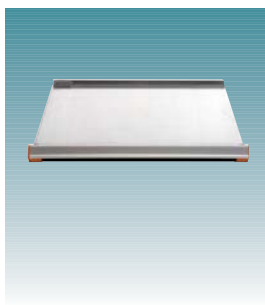

400 lb capacity, 100% extension;

Heavy-duty construction;

Easy to install;

Galvanized steel with 1 1/2" edge on back;

Height : 5";

May serve as work surface.

Product #	W x D
RF44-2421	24" x 21"
RF44-2427	24" x 27"
RF44-3021	30" x 21"
RF44-3027	30" x 27"
RF44-3618	36" x 18"
RF44-3624	36" x 24"
RF44-4824	48" x 24"
RF44-4827	48" x 27"
RF44-6024	60" x 24"
RF44-6027	60" x 27"

Drawer Lock

L3

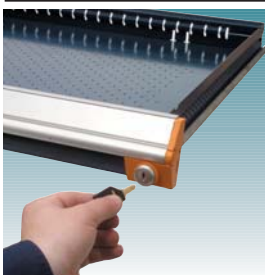

Compatible with all drawer dimensions;

Does not affect usable drawer space;

Easy to retrofit;

Order by adding L3 to drawer or partitioning model number. Ex. : RF31-362406L3.

Product #
L3

Specify the type of key desired : KA, KD, or MK.
When unspecified, a KD lock is supplied

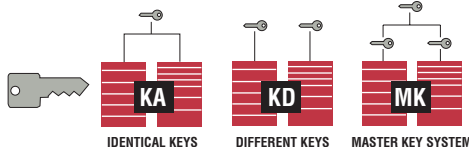

Heavy-Duty Front Access Roll-Out Shelf

RF40

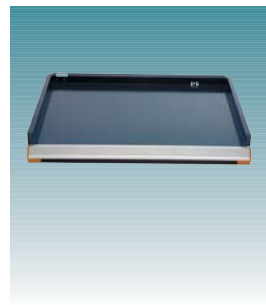

400 lb capacity, 100% extension;

Heavy-duty construction;

Easy to install;

Painted steel with 3" edges on sides and back;

Height: 6";

Full access to contents.

Product #	W x D
RF40-2421	24" x 21"
RF40-2427	24" x 27"
RF40-3021	30" x 21"
RF40-3027	30" x 27"
RF40-3618	36" x 18"
RF40-3624	36" x 24"
RF40-4824	48" x 24"
RF40-4827	48" x 27"
RF40-6024	60" x 24"
RF40-6027	60" x 27"

Integrated Lock-In Mechanism

A



Activated by tilting the handle up;

Allows user to open the drawer and the roll-out shelf with one hand only;

Close by simply pushing it;

Stops drawer and roll-out shelf from opening on their own;

Easy to retrofit;

Order by adding A to the drawer or partitioning, or roll-out shelf model number.
Ex. : RF31-362406A.

Product #
A

Econo Lock-In Mechanism

B

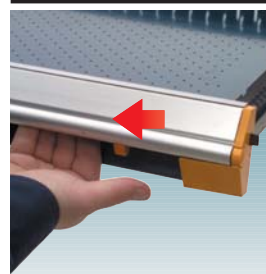

Activated with the right hand by sliding the mechanism with thumb;

Drawer and roll-out shelf close without having to reactivate the slide mechanism;

Stops drawer and roll-out shelf from opening on their own;

Easy to retrofit;

Order by adding B to the drawer or partitioning, or roll-out shelf model number.
Ex.: RF31-362406B.

Product #
B

Lock-Out Mechanism

RF85

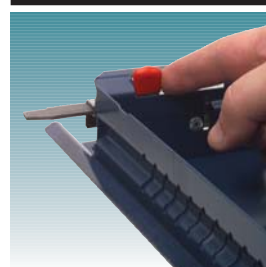

For both drawers and roll-out shelves;

Locks drawers and roll-out shelves in open position;

Activated manually, only when required;

No interference with drawer accessories.

Product #
RF85